

**OLYMPUS**<sup>®</sup>

Your Vision, Our Future

Inverted Metallurgical Microscopes

**GX SERIES**

**UIS2**  
World-leading optics

INVERTED METALLURGICAL MICROSCOPES



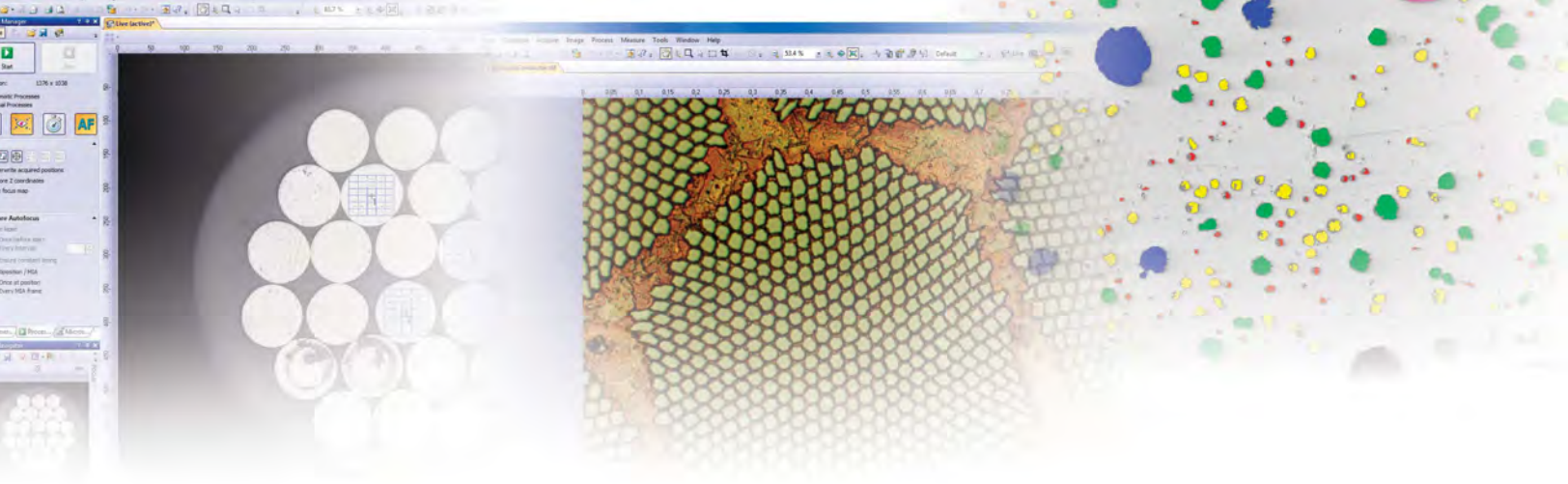

## Industry-leading\* UIS2 Optics Take Digital Micro Imaging Systems to the Next Generation

The optical system, heart of a microscope, uses our UIS2 infinity-corrected optical system evolved from the industrial leading UIS2 optical system. High quality images are obtained for every observation method, and the performance of the digital camera is optimized in flexibility. Digital images transferred to a PC can be easily used by use of advanced image analysis software.

The GX series is Olympus' most advanced inverted metallurgical microscope system. With addition of motorized functions, complete integration into all digital imaging subsystem is possible to provide advanced solutions for cutting edge research by its digital imaging system in pursuit of high quality and simplicity, motorized modules which increase observation efficiency, and other beneficial features.

The GX Series also strongly promotes environmentally-friendly manufacturing with a lead-free optical system.





Gran Size according to Intercept Method ASTM E112  
(Image Results)

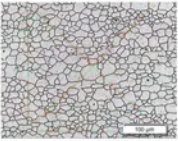

Sample Information:  
 Reference: Sample 01  
 Method: Stream  
 Image Name:   
 Number of Pictures:   
 Picture Length:   
 Image Contrast:   
 Field/Date: 01  
 1301.02



**GX51+DP21**



Specimen: 8-layer printed circuit board (Section)  
Specimen courtesy of Miyamagiken Co., Ltd.



**GX71 (motorized model) +DP73**

\* According to Olympus own survey of the wavefront aberration control in the top grade objective lenses marketed in 2008.



# Images of the Excellent Performance Created with UIS2 Wavefront Aberration Control

## A New standard of the objective lens performance, using wavefront aberration control

The Olympus UIS2 objective lenses set a new standard, with wavefront aberration control in addition to common performance standards of N.A. and W.D. Olympus challenges top grade optics which has not been fulfilled by the conventional standards. We offer excellent performance objective lenses by lowering the aberrations that lower resolution.

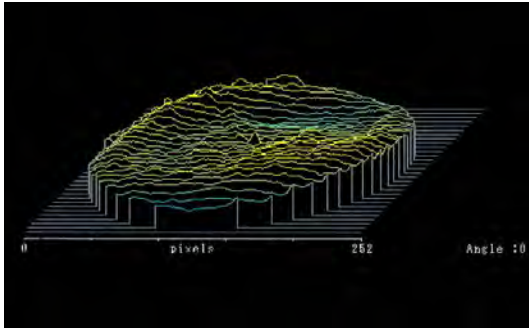

An example of 3D display of a wave front measured with a laser interferometer. The flatter the surface of the lens, the better the aberration correction becomes.

## Natural color reproduction faithful to the specimen

UIS2 objective lenses realize natural color reproduction without any chromatic shifts using stringently selected high transmittance glass and advanced coating technology that provides high transmittance which is flat over a wide band wavelength. In addition, since the total optical system, including the tube lens is designed to reproduce a natural color, clear images faithful to the specimen are obtained even with digital imaging.

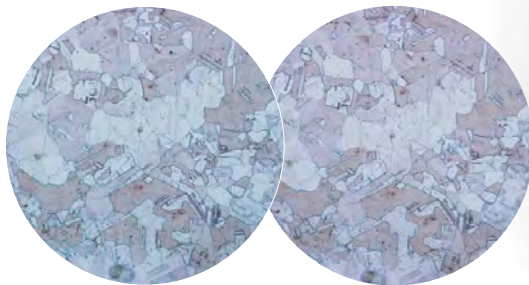

UIS2 image

Conventional image

## Color temperature comparison

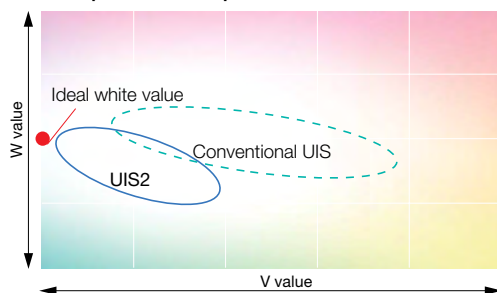

A comparison of the color temperature of UIS2 objective lenses and conventional UIS objective lenses. The color temperature of the UIS2 objective lenses is within a range which is very close to the color temperature target, which represents ideal white value.





**Removes spot flare during low magnification observation**

When a low reflection specimen is observed in lower power magnifications, spot flare may hinder precise observation. In UIS2 low power observation, a depolarizer built into the objective lens end removes spot flare and, a clear, high contrast image is obtained by combining a set of polarizer and analyzer plate.

\* 1.25x and 2.5x objective lenses available

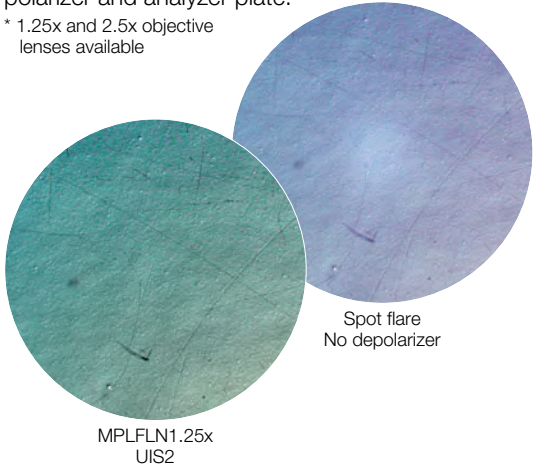

■ **Spot flare removal principle conceptual diagram**

Since the light reflected from the surface of the objective lenses is the linearly-polarized light "as is", it is eliminated by analyzer at Crossed Nicol position and has no affect on the image. On the other hand, the light passed through the depolarizer at the end of the objective lens becomes unpolarized light, and when the unpolarized light reflected from the specimen passes through the analyzer, only the linearly-polarized light that matches the vibration direction of the analyzer passes through and forms an image.

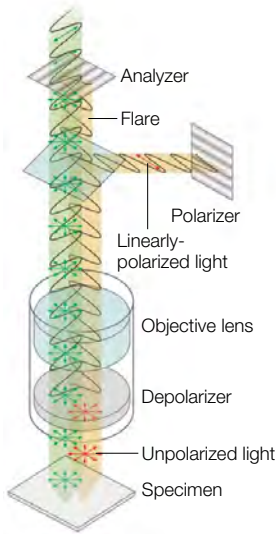

**Promotes environmentally-friendly ecologization and weight reduction**

Olympus has considered the environment and has tackled ecologization of microscopes. As part of this, on introduction of UIS2 optical system, eco-friendly glass free of lead and arsenic is used in the objective lenses and the major Semi-apochromatic UIS2 objective lenses are lightened by approximately 2/3. This contributes to prevention of environmental pollution, improvement of operability of objective lenses replacement, etc.

\*Some UIS2 objective lenses are the same weight as conventional objective lenses



# High-performance Research and Quality Control are Enhanced by Automated Modules

## Operations that you want to save — various powered modules fulfill your requirements

Thanks to various motorized modules, speedy magnification change, easy observation mode selection from brightfield to simple polarizing and illumination filter switching are performed through hand control panel or PC. Automation allows the operator to focus on the crisp UIS2 images. You only need to add the automation you need without adding any extras.

- Motorized revolving nosepieces U-D6REM, U-D5BDREM and motorized filter wheel U-FWR can also be added onto the GX51.
- Image analysis software OLYMPUS Stream is required for control from a PC.

## Getting the optimized image with any observation method

The UIS2 infinity-corrected optical system was developed with Olympus unique knowledge — and the GX series is designed to perform well in the context of inverted metallurgical microscopes. The results are sharp, detailed images with excellent contrast and consistently high clarity with any and all observation methods. Equipped with 100 W halogen lamp and newly improved efficiency, the GX series microscopes provide the intense and even illumination.

## The bright darkfield images

The UIS2 contrast has improved brightness and delivers better sensitivities for holes or flaws on metallographic structure.

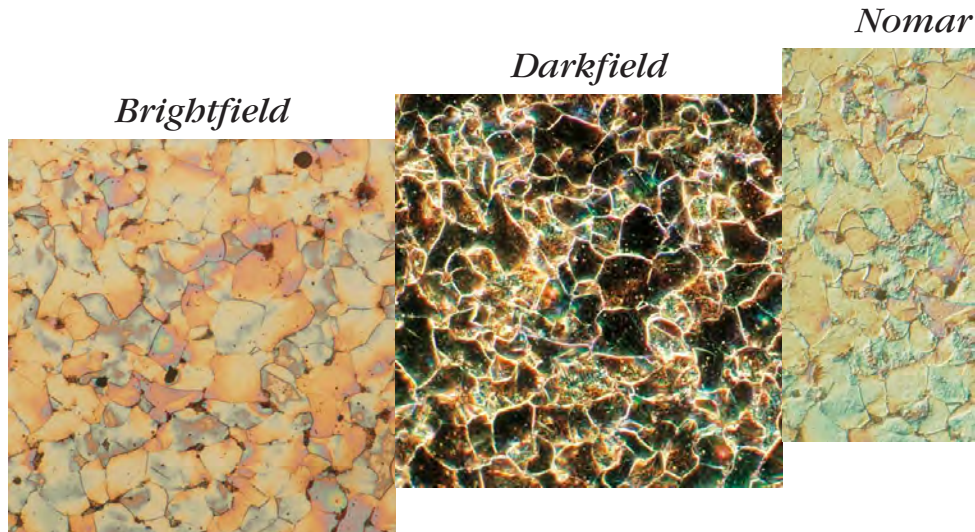
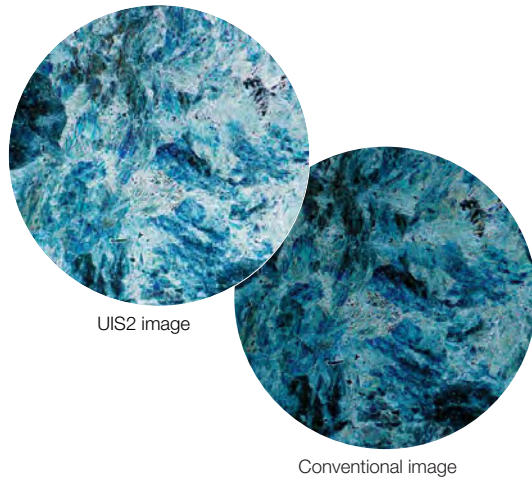

The GX71 motorized configuration requires the control box, IX2-UCB and the cable, U-REMMT.

Nomarski DIC

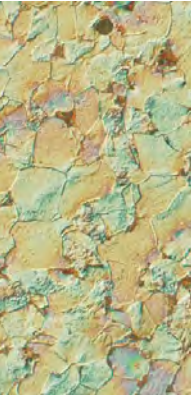

Simple polarizing

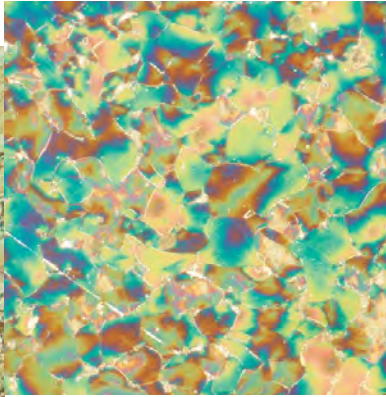

Fluorescence

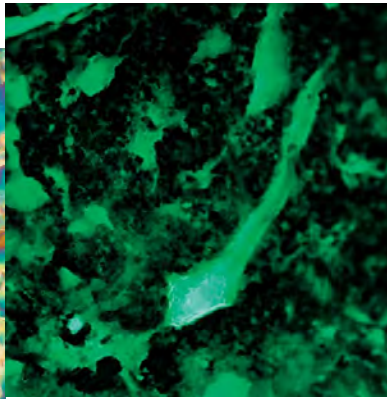

Motorized reflected light on/off



Motorized reflected filter wheel/  
U-FWR



Hand switch/U-HSTR2

**Nomarski DIC system provides an optimum image suited to the sample**

Olympus Nomarski DIC observation uses a simple observation switching slider type single prism system. Three different DIC prisms are provided: the U-DICR for all imaging applications, high resolution U-DICRH, and high contrast U-DICRHC, so that the excellent resolution and contrast matched to the state of the sample are obtained. Since the exit pupil position of the objective lens is standardized by the series, the position of the DIC prism does not have to be switched when the magnification was changed by switching the objective lens.

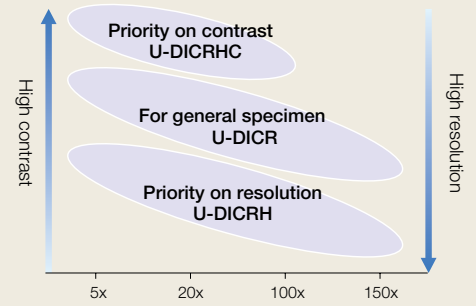



# Digital Micro Imaging Solutions for Obtaining High Quality Microscopic Images

## Digital imaging ? No, it is digital micro imaging

High resolution objective lenses, high transmittance optical system and uniform brightness illumination system extract excellent performance from the digital camera. Olympus offers two types of digital imaging device, space-saving simple-operation standalone models, and completely controlled PC-basis models, for all observation methods ranging from brightfield to fluorescence. Choose the camera matched to your purpose and budget. Olympus offers digital micro imaging solutions for microscopes based on many years of optoelectronics technologies.

## Accurate post-imaging measurements

Integration with a coded revolving nosepiece allows sharing and recording of objective lens magnification. A coded revolving nosepiece eliminates errors that occur when the wrong magnification is manually recorded by the operator. The coded revolving nosepiece is available in two types; for brightfield objective lens and for brightfield/darkfield objective lens.



## UIS2 objective lenses with excellent image parcentricity

High power Semi-apochromatic UIS2 objective lenses make the centration tolerance between objective lenses on the microscope nosepiece keep the image within the center of the field of view even with digital cameras.

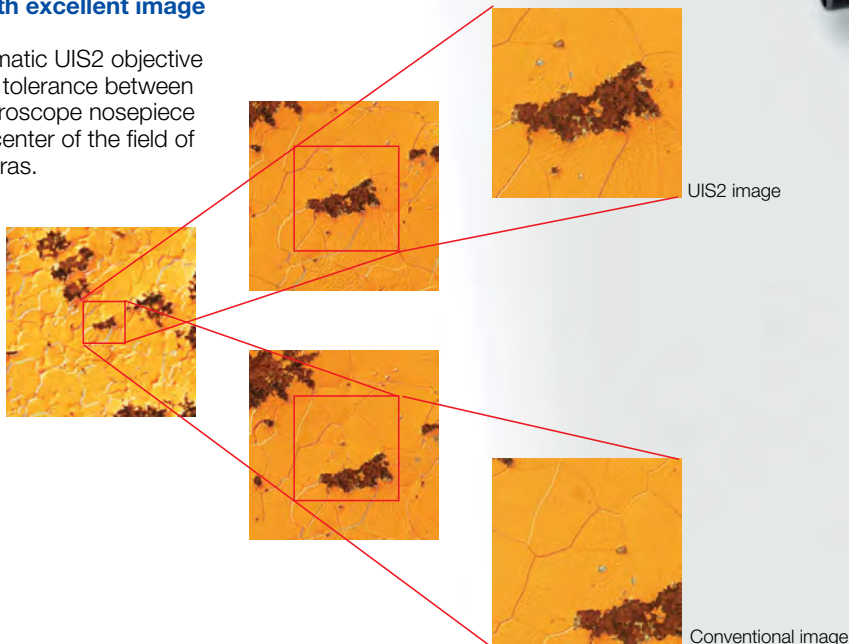





### **Digital Camera DP21/DP26**

#### **Smooth live image display High-speed image capturing which allows sequential shooting**

The 2-megapixel color CCD camera, DP21 can be controlled from a space intuitively operated hand-switch. The camera has the power to display UXGA images comparable to high-definition at a smooth 15 frames per second. Seamless viewing is sustained even when changing focus or moving the inspection spot. The hand-switch incorporates the 12 most frequently used measurement functions for efficient inspection of industrial parts.

The high-resolution 5-megapixel color CCD camera, DP26 provides excellent performance in brightfield observation for most applications. The DP26 incorporates progressive scanning that is free from color shift and offers high-speed IEEE1394b connectivity. Handset type is also optional.

Both models accommodate a wide range of applications in the OLYMPUS Stream, imaging analysis software.



### **High-resolution Digital Camera DP73**

#### **Captures High-resolution, High-sensitivity Digital Images Fast**

This outstanding 17.3-megapixel cooled digital camera with pixel-shift technologies attains superior resolving power, sensitivity and precise 14-bit (16384 steps) color fidelity. The DP73 is compatible with all the light microscopic observation methods and produces contrast balanced images using a unique dynamic range technology. ISO1600 sensitivity delivers clear display even for faint fluorescence signals.

A high definition 1600 x 1200-pixel image can be displayed live at a rate of 15 frames per second, without compression and a maximum 4800 x 3600-pixel image can be instantly saved.



# Making the Optimal Use of Microscope Digital Imaging OLYMPUS Stream—the More Freedom, the More Comfort

## Keep your workflow streamlined

In addition to control digital cameras, microscopes and coded revolving nosepieces, the OLYMPUS Stream image analysis software has made possible seamless operation throughout your workflow: an easy-to-use interface guides you effortlessly through every step from image adjustment and capture, measurements, report creations and archiving—or whatever you need to achieve. The OLYMPUS Stream software system can be purchased in a variety of packages designed to fit your needs.

## Count and measure\*

Object detection and size distribution measurement are among the most important applications in digital imaging. OLYMPUS Stream incorporates a detection engine that utilizes threshold methods to reliably separate objects (e.g. particles, scratches) from the background. OLYMPUS Stream offers more than 50 different parameters for shape, size, position, and pixel properties (intensity, gray value) for object classification.

\*Optional software for OLYMPUS Stream Essentials and more-advanced packages

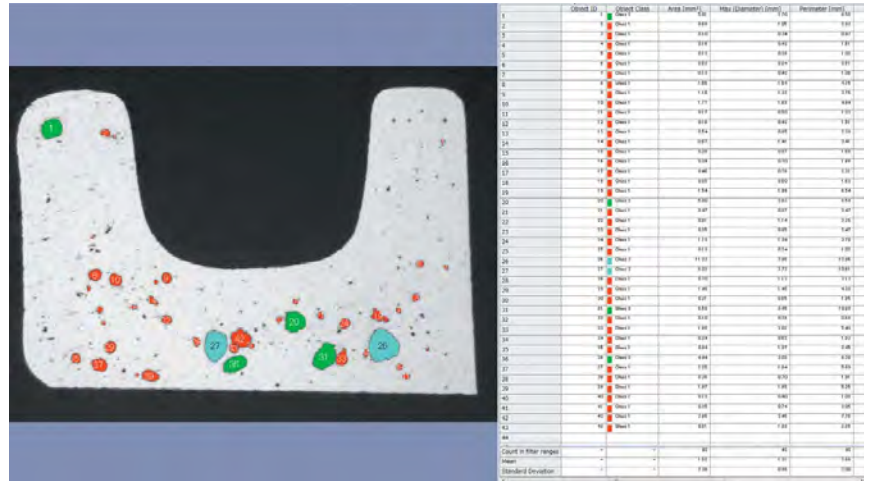

Object detection and classification

## Live image navigation

Using the OLYMPUS Stream image navigation allows you to pan and zoom on live or stored images. The image navigator interface provides immediate updates at your location on both the zoomed and unmagnified images. The navigation system provides you with fast, immediate views of your sample before you acquire an image. All image viewing and manipulation is carried out with a clean, simple user interface, providing fast and intuitive results.

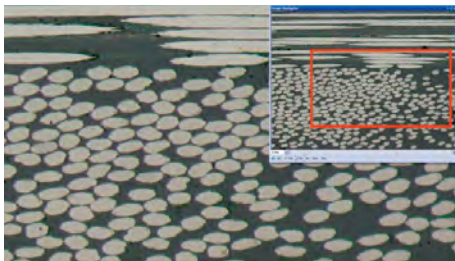

Live image navigation (composite material)

## Basic measurement

OLYMPUS Stream provides interactive measurement functions such as distances, angles, rectangles, circles, ellipses and polygons. The measurements are made with your mouse and show immediate feedback indicated on the image or in the live data table. All results are saved with the image files as records. To further improve on accuracy, optical data such as system magnification are automatically available when combined with the Olympus Microscope system.



Measurement result using Magic Wand\*\* (cast iron)

\*\*Available for OLYMPUS Stream Essentials and more-advanced packages

## Manual Multiple Image Alignment (MIA)

OLYMPUS Stream software provides MIA to enable the creation of panoramic images of samples that extend beyond the field of view. The simple step-by-step process allows you to quickly combine the images. The OLYMPUS Stream software then quickly stitches them together, providing you with an output ready for simple visualization or complex measurement.

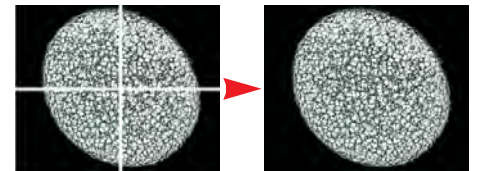

Multiple image acquisition of shape memory alloy

## Report generation

Save your data and export it to your customized report, which can be edited in Microsoft Word.

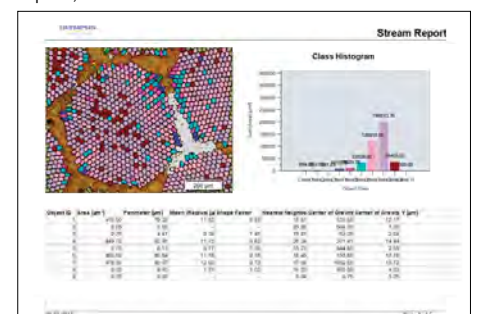



## OLYMPUS Stream provides intuitive workflow interfaces

With the click of an icon on the Materials Solution tool window, you can execute the most complex image analysis task quickly, precisely, and in compliance with most common international standards.

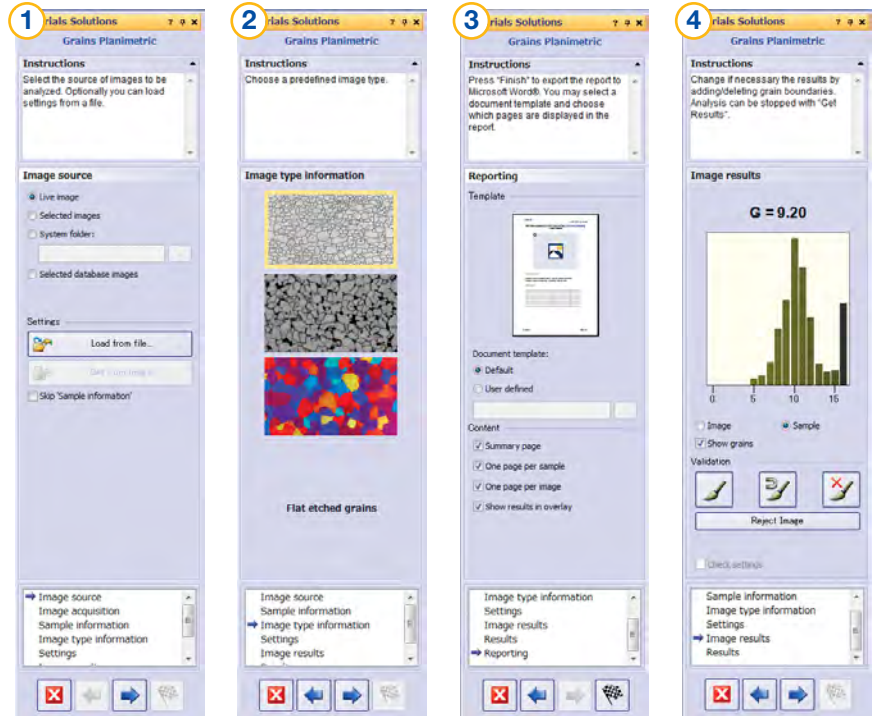
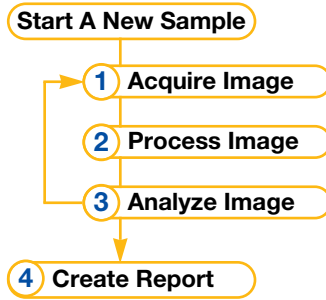

Example: Grains Planimetric

### Grain sizing intercept/planimetric

This module is for steel manufacturers measuring and controlling grain size after cross-sectioning, polishing or etching steel samples. OLYMPUS Stream can calculate the grain size number G by the intercept or planimetric method automatically with no time consuming manual actions. The results are created according to international standards (JIS G5502, ASTM E112, and DIN50601).

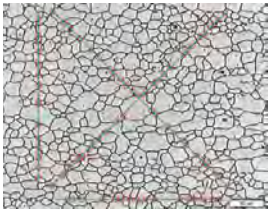

Grain sizing (intercept)

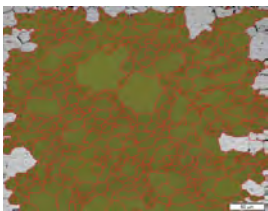

Grain sizing (planimetric)

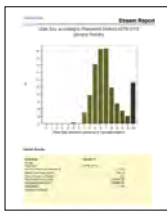

### Cast iron

This module is for casting manufacturers who need to measure and control the graphite nodularity to check the mechanical characteristics of their cast products. With OLYMPUS Stream, this nodularity can be calculated by graphite size, shape, and distribution. The results are automatically created according to industrial standards (JIS G5502, ASTM E247, and ISO945).

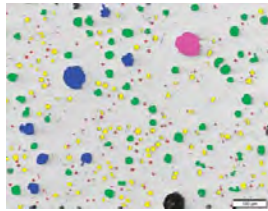

Polished cast iron



### Non-metallic inclusion rating in steel

This module is for steel manufacturers measuring and controlling the shape and size of non-metallic inclusions (oxide, alumina, sulphide, or silicate) in steel. OLYMPUS Stream can evaluate non-metallic inclusion with the results created automatically according to international standards (ASTM E45 Method A and DIN 50602 Method M).



Non-metallic inclusion rating in steel



### Chart comparison

A live or still image can be compared with standard charts. Overlay comparisons can be made, and function preview is available. This module can be used for ASTM grain size number evaluation, non-metallic inclusion rating, and cast-iron shape class evaluation. Steel microstructure with superimposed reference image as overlay for live evaluation.

TOP-OF-THE-LINE INVERTED  
METALLURGICAL SYSTEM MICROSCOPE

# GX71

BF

DF

DIC

POL

FL

F.N.  
26.5

MAX  
4 Ports

2x  
ZOOM

## Top-notch Performance for Today's Leading-edge Research



### Zoom function for easy framing

The 1x-2x zoom facility acts on all ports, shows critical specimen detail more clearly and makes accurate framing especially easy as well as allowing image capture at the same magnification as the visual observation.

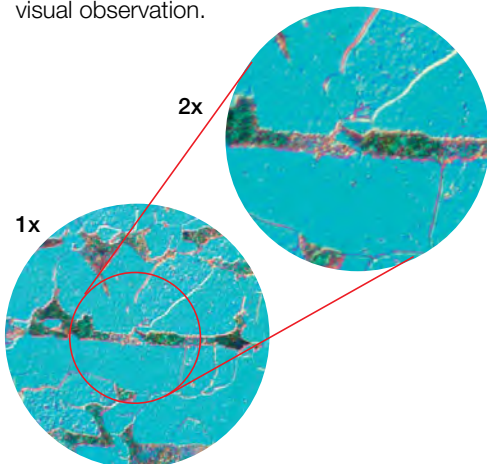

### Truthful reproduction of specimen in image forming and acquisition

Viewing images are not reversal, the exact reproduction of specimen in vertical/horizontal directions. The true reproduction makes it easier to compare the images with digital photos.

\*Images are reversed if seen via a video/digital camera attached to the side/front port.

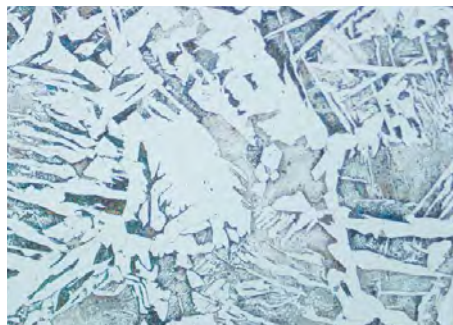

### Five observation methods from brightfield to fluorescence

Simply by changing the position of the GX71's mirror unit turret, it is quick and easy to alternate between brightfield, darkfield, Nomarski DIC, simple polarized light and fluorescence observation. The Olympus universal objective lenses accommodate all observation methods. There is no need to change the objective lens type each time the observation method is changed. The GX71 also employs super widefield eyepieces (F.N.26.5), for an efficient orientation and observation process.





## Superb Performance and Reliability for All Kinds of Routine Observation and Documentation



### Single lever switchover for brightfield/darkfield observation

The versatile GX51 performs brightfield, darkfield, Nomarski DIC and simple polarized light observations. Switching between brightfield and darkfield observation is done with a single lever, located close to the operator's hand. Changing to Nomarski DIC observation is a simple matter of inserting the DIC-slider.



### Expandable functionality

A wide variety of optional units can be easily attached to the GX51, allowing such system upgrades as linking to a digital or video camera via an intermediate tube (GX-SPU).



### Designed for ease to use and efficiency

Good working efficiency is the top design priority of the GX51, which was specially developed for handling routine inspection tasks. Its most frequently used operating features are located at the front, while incorporation of the tilting tube U-TBI90 (elevation angle 35-85 degree) allows the operator to work in an easy, natural posture and conduct observations comfortably in a standing position.



# GX71/GX51 ACCESSORIES



\*Use in combination with 10x lens for drawing attachment U-DAL10x.

GX71

## Drawing attachment / U-DA

As well as its conventional use as drawing attachment, this accessory also provides a macro observation function. When combined with a trinocular observation tube, the macro images are stored as photomicrographs or retained in the digital camera.



GX71 GX51

## Lamp housing

A variety of light sources to accomplish bright and even illumination are provided, according to your purpose.



GX71

## GX71 observation tubes

The super widefield binocular observation tube (U-SWBI30) and super widefield trinocular observation tube (U-SWTR-3) are provided for the GX71.



GX71 GX51

## Revolving nosepieces

Sextuple revolving nosepieces and quintuple revolving nosepieces with DIC slider compatibility are also provided.



\*Use U-BI90CT in combination with U-EPA2 or GX-SPU.

GX51

## GX51 observation tube

Besides trinocular tube U-TR30H-2, the lineup includes binocular tube U-BI90, for use in combination with an eyepoint adjuster, and tilting tube U-TBI90, which allows observations to be made in whatever posture suits the individual user.



GX71 GX51

## Filters

The GX series comes with a select range of filters, including neutral density, color temperature conversion and green filters. Two slider slots are provided, each allowing introduction of up to three filters.



GX51

## Intermediate tubes

Other high-performance accessories are available to meet a variety of applications. Included are an intermediate tube (IX-ATU), which allows attachment of a trinocular observation tube, a side port intermediate tube (GX-SPU) and an eyepoint adjuster (U-EPA2).



GX71 GX51

## Scales

In addition to the calibration scales for each objective lens, grain size reticules and square scales can also be recorded. Up to 3 scales can be freely combined in a single slider.



## GX series specifications

		GX71	GX51
Optics		UIS2 optical system (infinity-corrected)	
Microscope frame	Intermediate magnification	Zoom incorporated (1 x–2 x) Clicks in the two intermediate positions (can be released)	—
	Imprinting of scale	All ports Reversed positions (up/down/left/right) from observation positions seen through the eyepiece	All ports Reversed positions (up/down) from observation positions seen through the eyepiece
	Power source	Power source for illuminator (12 V 100 W halogen) incorporated	
	Focusing	Manual, Coarse and Fine coaxial handle. Focus stroke 9 mm (2 mm above and 7 mm below the stage surface)	
	Output port	Front port — Video and DP system (reversed image, special video adapter for GX) Side port — Video, DP system (reversed image)	Side port (option) — Video, DP system (upright image)
Observation tube	Super widefield (F.N. 26.5)	U-SWB130, U-SWTR-3	
	Widefield (F.N. 22)	—	U-BI90, U-TR30H-2
Illumination	Observation method	Brightfield, darkfield, simple polarized light, DIC, fluorescence	
	Illuminator diaphragm	FS/AS manually controlled, with centering adjustment	
	Light source	100 W halogen (standard), 100 W mercury, 75 W xenon (option)	
Revolving nosepiece	Manual operation	Sextuple for BF/DIC, quintuple for BF/DF, quintuple for BF/DF/DIC, coded quintuple for BF, coded quintuple for BF/DF/DIC, centerable quadruple for BF	
	Motorized operation	Sextuple for BF/DIC, quintuple for BF/DF/DIC	
Stage	Standard type	Right handle stage for GX (X/Y stroke: 50 x 50 mm)	
	Option	Flexible right handle stage, left short handle stage (each X/Y stroke: 50 x 50 mm), Gliding stage	
	Stage insert plate	A set of teardrop and long hole types	
Image recording	Digital camera, video camera	OLYMPUS DP series etc, attachable using appropriate adapters	
Combined weight		Approx. 39 kg (BF, DF and DIC observations, combined with DP73)	Approx. 28 kg (BF, DF and DIC observations, combined with DP21)
Input rating		100–120/220–240 V 1.8/0.8 A 50/60 Hz	

## UIS2 objective lens specifications

Objective lenses	Magnifications	N.A.	W.D. (mm)	Cover Glass Thickness* <sup>1</sup> (mm)	Resolution* <sup>2</sup> (μm)
MPLAPON	50x	0.95	0.35	0	0.35
	100x	0.95	0.35	0	0.35
MPLAPON	100xOil* <sup>3</sup>	1.4	0.1	0	0.24
MPLFLN	1.25x* <sup>4,5</sup>	0.04	3.5	—	8.39
	2.5x* <sup>4,5</sup>	0.08	10.7	—	4.19
	5x	0.15	20.0	—	2.24
	10x	0.30	11.0	—	1.12
	20x	0.45	3.1	0	0.75
	40x* <sup>6</sup>	0.75	0.63	0	0.45
	50x	0.80	1.0	0	0.42
MPLFLN-BD* <sup>7</sup>	100x	0.90	1.0	0	0.37
	5x	0.15	12.0	—	2.24
	10x	0.30	6.5	—	1.12
	20x	0.45	3.0	0	0.75
	50x	0.80	1.0	0	0.42
	100x	0.90	1.0	0	0.37
MPLFLN-BDP* <sup>7</sup>	150x	0.90	1.0	0	0.37
	5x	0.15	12.0	—	2.24
	10x	0.25	6.5	—	1.34
	20x	0.40	3.0	0	0.84
	50x	0.75	1.0	0	0.45
LMPLFLN	100x	0.90	1.0	0	0.37
	5x	0.13	22.5	—	2.58
	10x	0.25	21.0	—	1.34
	20x	0.40	12.0	0	0.84
	50x	0.50	10.6	0	0.67
LMPLFLN-BD* <sup>7</sup>	100x	0.80	3.4	0	0.42
	5x	0.13	15.0	—	2.58
	10x	0.25	10.0	—	1.34
	20x	0.40	12.0	0	0.84
	50x	0.50	10.6	0	0.67
100x	0.80	3.3	0	0.42	

Objective lenses	Magnifications	N.A.	W.D. (mm)	Cover Glass Thickness* <sup>1</sup> (mm)	Resolution* <sup>2</sup> (μm)
MPLN* <sup>7,8</sup>	5x	0.10	20.0	—	3.36
	10x	0.25	10.6	—	1.34
	20x	0.40	1.3	0	0.84
	50x	0.75	0.38	0	0.45
	100x	0.90	0.21	0	0.37
MPLN-BD* <sup>4,7,8</sup>	5x	0.10	12.0	—	3.36
	10x	0.25	6.5	—	1.34
	20x	0.40	1.3	0	0.84
	50x	0.75	0.38	0	0.45
	100x	0.90	0.21	0	0.37
LCPLFLN-LCD	20x	0.45	8.3–7.4	0–1.2	0.75
	50x	0.70	3.0–2.2	0–1.2	0.48
	100x	0.85	1.2–0.9	0–0.7	0.39

\*<sup>1</sup> — : Applicable to the view of specimens with/without a cover glass  
0 : Applicable to the view of specimens without a cover glass.

\*<sup>2</sup> Resolution values are calculated with the aperture diaphragm fully opened.

\*<sup>3</sup> Specified oil: IMMOIL-F30CC.

\*<sup>4</sup> Field numbers are limited (up to F.N.22). Not compatible with F.N.26.5.

\*<sup>5</sup> Analyzer and polarizer are recommended to the usage with MPLFLN1.25x or 2.5x.

\*<sup>6</sup> The MPLFLN40x objective lens is not compatible with the differential interference contrast microscopy.

\*<sup>7</sup> "BD" refers to brightfield and darkfield objective lenses

\*<sup>8</sup> Slight vignetting may occur in the periphery of the field when MPLN-BD series objective lenses are used with high-intensity light sources such as mercury and xenon for darkfield observation.

## GX71 dimensions

(unit: mm)

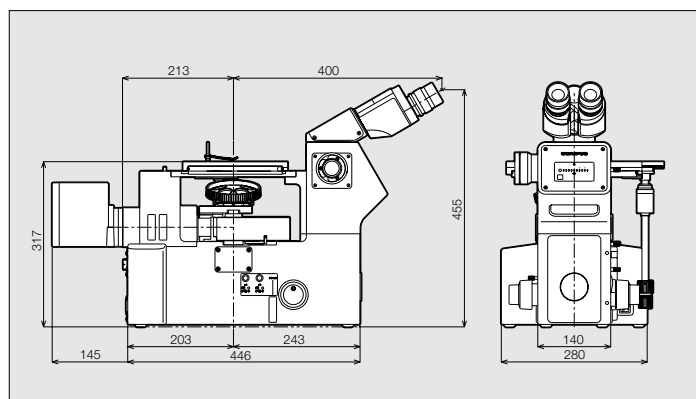

## GX51 dimensions

(unit: mm)

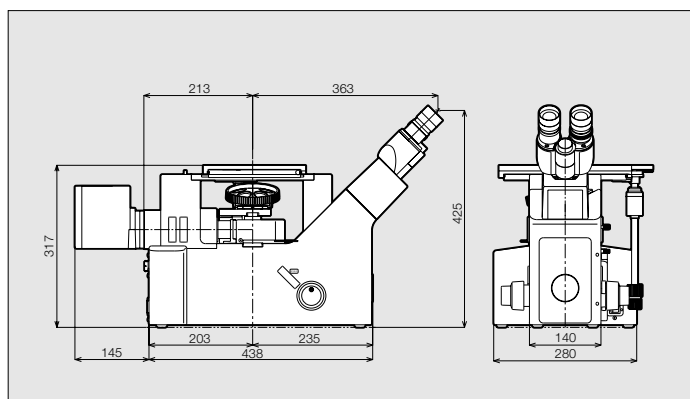

# SYSTEM DIAGRAM

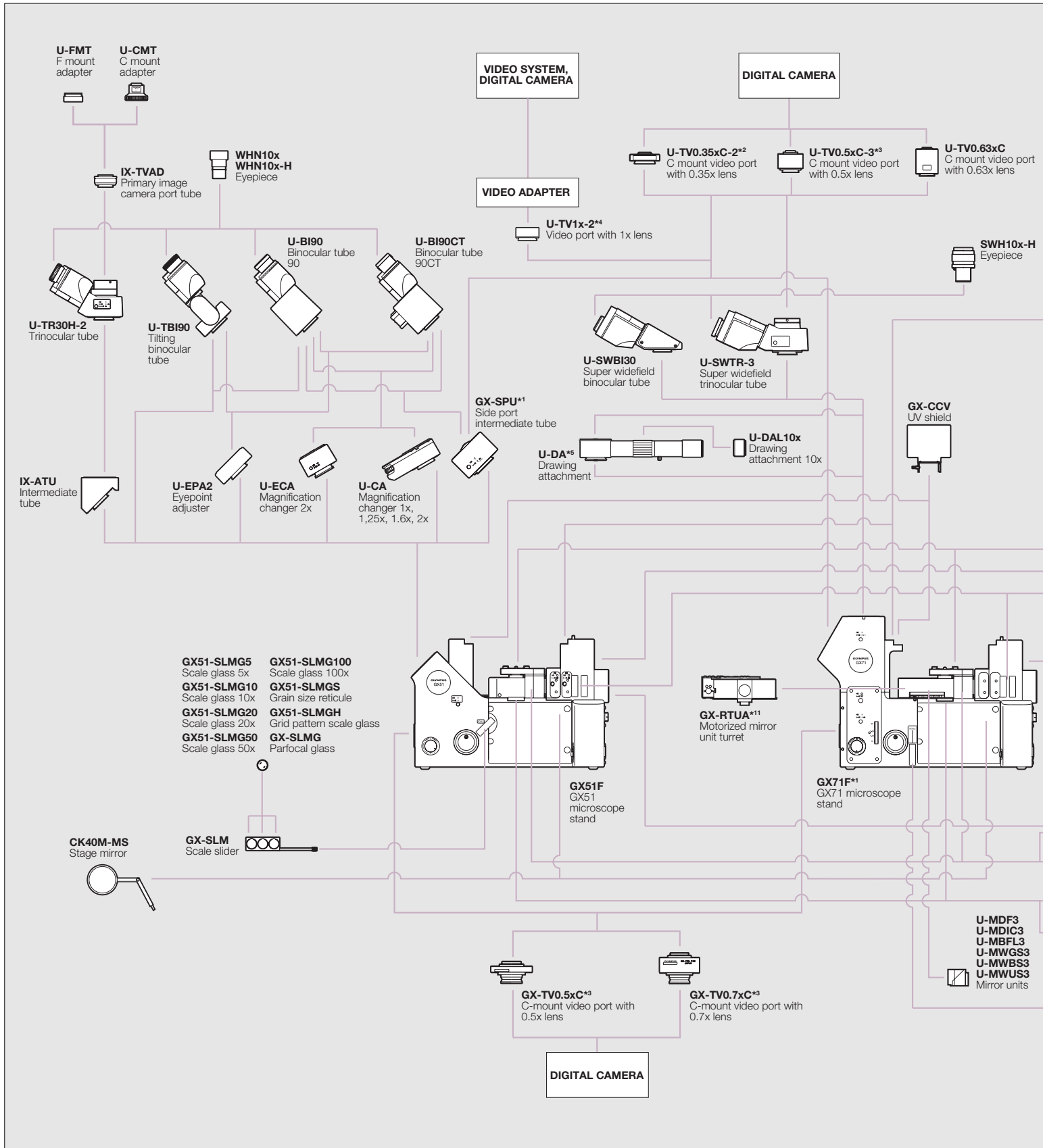

\*1 Please consult your nearest Olympus dealer for cameras compatible with the GX71F side port and GX-SPU.  
 \*2 Using the camera with an image sensor less than 1/2 inch in size. Even in this case, illumination near the perimeter of the field of view may slightly insufficient.  
 \*3 Using the camera with an image sensor less than 2/3 inch in size.  
 \*4 Using the camera with an image sensor less than 1 inch in size.  
 \*5 Macro observation image sizes are fractionally smaller than the SWH10x-H field of view (F.N.26.5).  
 \*6 U-DICRH should be used exclusively with MPLFLN series objective lenses and U-DICRHC should be used exclusively with LMPLFLN series objective lenses.  
 \*7 IX2-UCB-2 power supply unit is required for U-D6REM and U-D5BDREM.



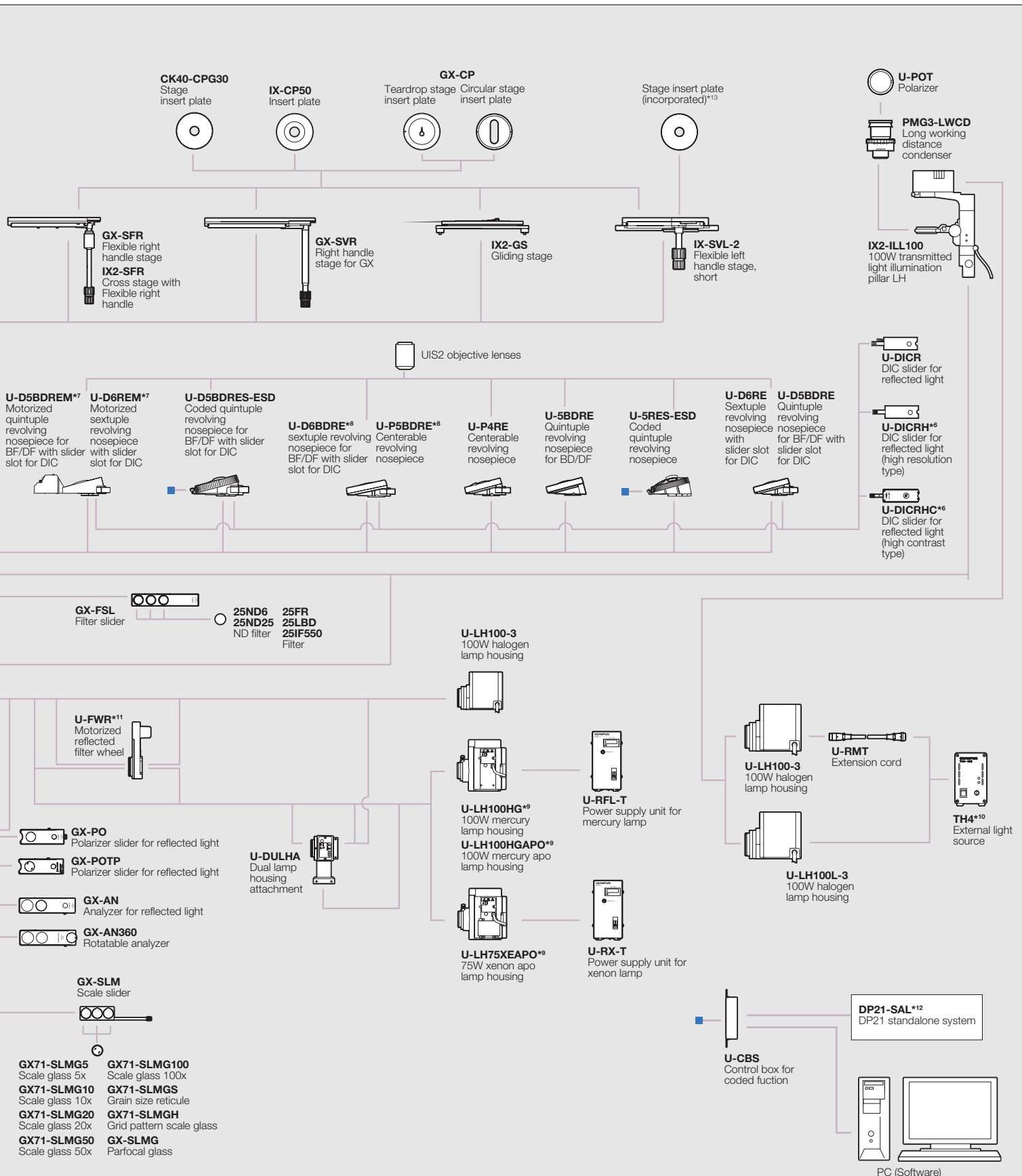

<sup>\*6</sup> Objective lenses may touch the stage when revolving the U-D6BDRE, U-P5BDRE incorrectly.  
<sup>\*7</sup> 25L42 filter is required for polarized light and Nomarski DIC observation using high intensity lamps such as U-LH100HG.  
<sup>\*8</sup> TH4 is only necessary when transmitted and reflected light illuminations are used simultaneously.  
<sup>\*9</sup> IX2-UCB and U-HSTR2 are required for U-FWR and GX-RTUA.  
<sup>\*10</sup> Connect with DP21 or DP26 microscope digital camera required.  
<sup>\*11</sup> When rotating the revolving nosepiece, objective lenses may touch the stage insert plate depending on the stage position.

[www.olympus-ims.com](http://www.olympus-ims.com)

**OLYMPUS**<sup>®</sup>

For enquiries - contact  
[www.olympus-ims.com/contact-us](http://www.olympus-ims.com/contact-us)

**OLYMPUS CORPORATION**

Shinjuku Monolith, 3-1, Nishi Shinjuku 2-chome, Shinjuku-ku, Tokyo, Japan

**OLYMPUS EUROPA HOLDING GMBH**

Wendenstrasse 14-18, 20097 Hamburg, Germany

**OLYMPUS AMERICA INC.**

3500 Corporate Parkway, Center Valley, Pennsylvania 18034-0610, U.S.A.

**OLYMPUS (CHINA) CO., LTD.**

11F, K, Wah Centre, 1010 Huaihai Rd(M), Xuhui District, Shanghai, P.R.C

- **OLYMPUS CORPORATION is ISO9001/ISO14001 certified.**
- **Illumination devices for microscope have suggested lifetimes.**
- **Periodic inspections are required. Please visit our web site for details.**
- All company and product names are registered trademarks and/or trademarks of their respective owners.
- Images on the PC monitors are simulated.
- Specifications and appearances are subject to change without any notice or obligation on the part of the manufacturer.

**OLYMPUS KOREA CO., LTD.**

Olympus-Tower, 114-9 Samseong-Dong, Gangnam-Gu, Seoul, Korea

**OLYMPUS SINGAPORE PTE LTD.**

491B River Valley Road, #12-01/04 Valley Point Office Tower, Singapore

**OLYMPUS AUSTRALIA PTY. LTD.**

31 Gilby Road, Mt. Waverly, VIC 3149, Melbourne, Australia

**OLYMPUS LATIN AMERICA, INC.**

5301 Blue Lagoon Drive, Suite 290 Miami, FL 331269, U.S.A.

M1699E-052013