

OLYMPUS®

BHS/BHT

System Microscopes



BH2 Series System Microscope

The BH2 Series of top-quality microscopes facilitates the use of a wide range of microscopic techniques, depending on the choice of accessories. The Koehler-type illumination elicits the full performance of the LB Series objectives, yielding photomicrographs of the highest quality. This series of microscopes is suitable for a very wide range of applications, from routine laboratory work to educational and research investigations.



This text is a mirror image of the text on the opposite page, appearing as bleed-through from the reverse side of the paper.

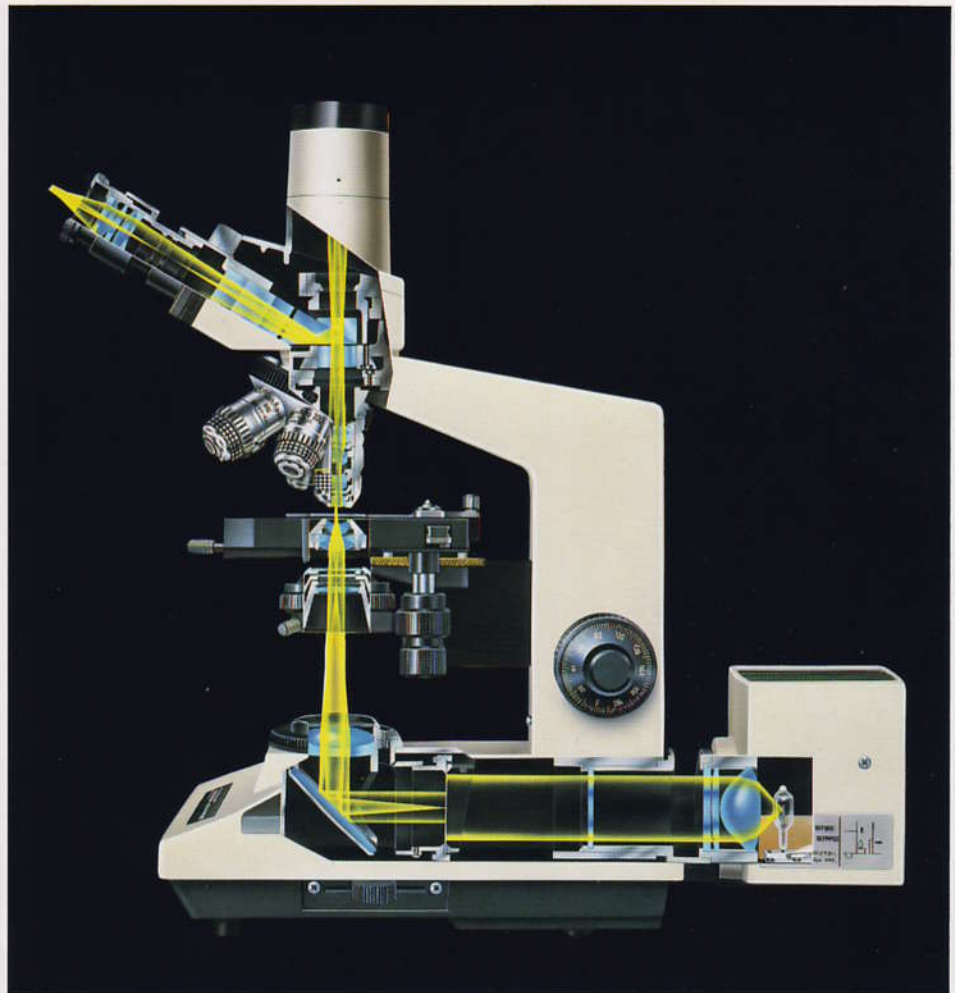

Outstanding Ergonometry

The design of the entire system—microscope stands, observation tubes, stages, etc.—bears witness to creative and inventive thinking. One example may be seen in the design of the coarse stage adjustment, in which movement is limited in the upward direction in order to prevent contact between objective and specimen. The coarse and fine focusing knobs are of coaxial design, and the minimum increment on the fine adjustment knob represents a stage movement of just two microns. The coaxial stage control knobs are located close to the focusing knobs, low enough to permit operation without having to raise the arm off the arm rest. In addition, the BH2-TR30 trinocular observation tube features constant tube length adjustment which allows camera focus

through the binocular tube in photomicrography, thereby adding significantly to ease of operation.

Improved Illuminating System

All BH2 Series microscopes employ the widely accepted LB Series objectives and WHK10X eyepieces (as standard equipment), providing F.N. 20 widefield observation. BH2 Series microscopes provide Koehler illumination to exploit the full benefits of the LB Series objectives. A wide choice of condensers provides uniform illumination from ultra low to high magnifications. These microscopes incorporate precentered halogen lamps, aspherical collectors and fully enclosed light paths designed to keep out dirt and dust.



BHS System Microscope

This top quality microscope features a long-life 12V, 100W halogen lamp which provides bright illumination for a wide range of applications. It is ideally suited for advanced research work and investigations requiring high precision.



Exhibiting the same excellent performance as the Model BHT microscope with a different type of illumination system and available accessories. A compact microscope with excellent performance.

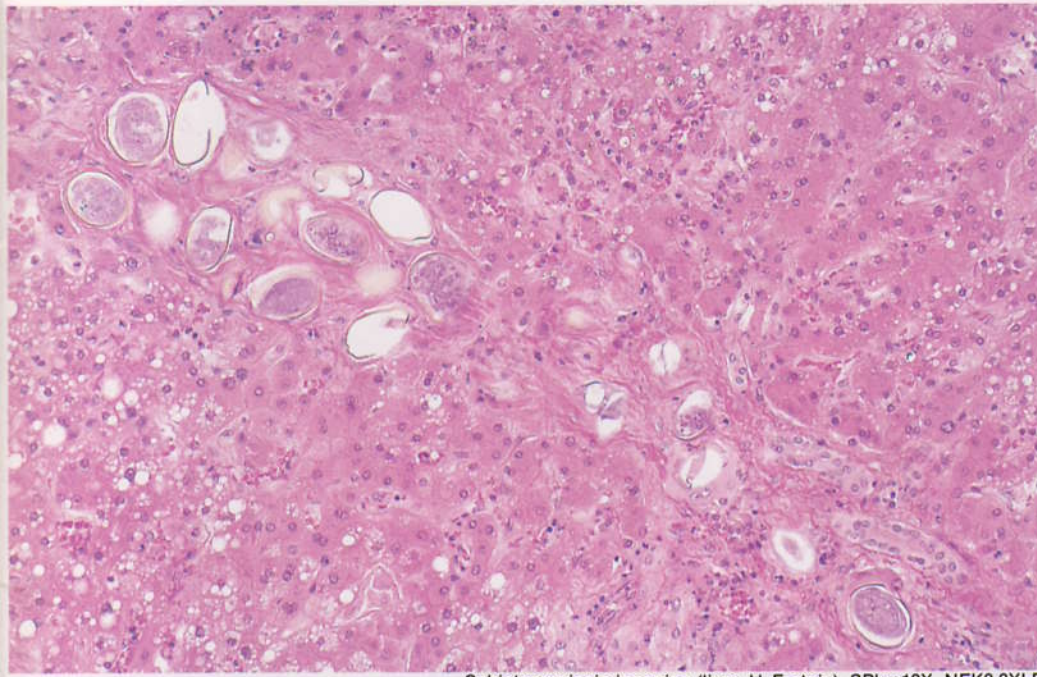

Schistosomiasis japonica (liver, H-E stain). SPlan10X, NFK3.3XLD

BHS-F Microscope Stand

- The BHS-F stand is of a robust and stable design unaffected by vibration or shaking. Highly reliable, it is ideal for photomicrographic purposes.
- The stand incorporates a high-performance transformer which is unaffected by fluctuations in the line voltage and so always provides light of uniform brightness and color temperature.
- The ball bearing sextuple revolving nose-piece accepts low to high magnification objectives with 45mm parfocal distance. This feature contributes significantly to greater efficiency in microscopy.

BHS-LSH Halogen Lamp Housing

The 12V 100W halogen lamp provides a bright light source suitable for many types of microscopy. The precentered lamp has an average life of around 2,000 hours, reducing significantly the time lost with troublesome bulb change.

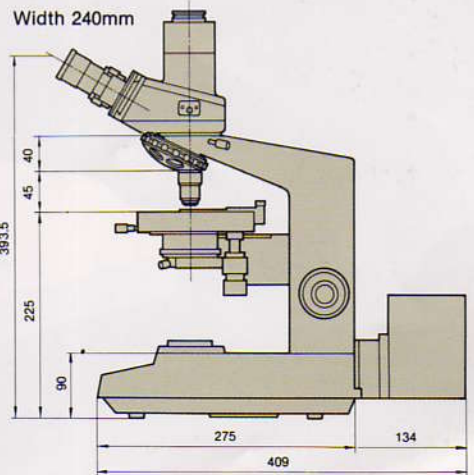

Standard Outfits

Module			BHS			
			112	113	312	313
Microscope Stand		BHS-F	○	○	○	○
Observation Tube	Binocular, 30° Inclined	BH2-BI30	○	○		
	Trinocular, 30° Inclined	BH2-TR30			○	○
Revolving Nosepiece	Sextuple	BH2-6RE		○		○
	Quintuple	BH2-5RE	○		○	
Mechanical Stage	Graduated	BH2-SVR	○	○	○	○
	Achromatic/Aplanatic	BH2-AAC		○		○
Condenser	Top Lens Swing-out/in	BH2-SC	○	○	○	○
Lamp Housing		BHS-LSH	○	○	○	○
Bulb	12V 100W Halogen	12V100W HAL-L(2pcs.)	○	○	○	○
Power Cord		UYCP	○	○	○	○
Objective	D Plan Achromat	4X	○	○	○	○
		10X	○		○	
		20X	○		○	
		40X	○		○	
	S Plan Achromat	100X oil	○		○	
		4X		○		○
		10X		○		○
		20X		○		○
	40X		○		○	
	100X oil		○		○	
Eyepiece	Viewing, Widefield, HEP	WHK10X(2pcs.)	○	○	○	○
	For photomicrography	NFK 3.3X LD			○	○

BHT System Microscope

Employing the same revolving nosepieces, stages, observation tubes, etc., as the Model BHS, the Model BHT microscope uses a different type of illumination system and electrical components. A compact microscope, it offers excellent cost-performance.



Objective and Condenser (Long Barrel)

The objective and condenser lenses are the most important parts of the microscope. They are responsible for gathering light from the specimen and focusing it to form a clear image. The objective lens is the lens closest to the specimen, and the condenser lens is the lens that focuses light onto the specimen. The quality of these lenses is crucial for the resolution and contrast of the image.

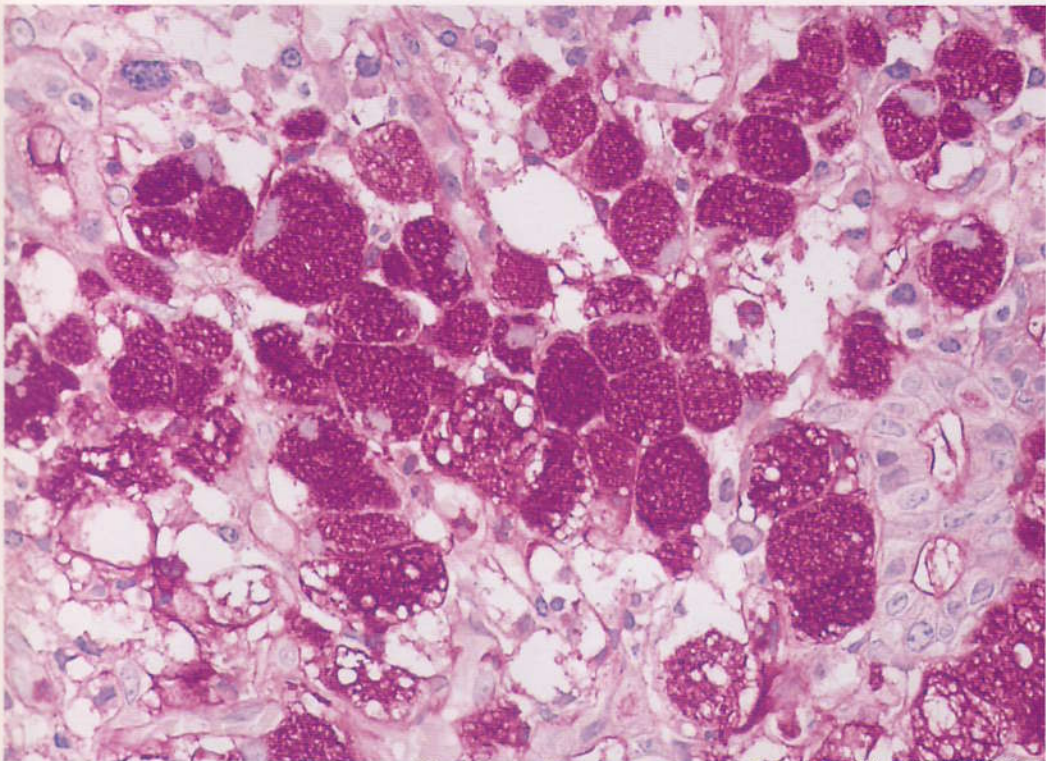

Signet ring cell carcinoma (stomach, PAS stain). DPlan40X, NFK3.3XLD

BHT-F Microscope Stand

- Smaller than the BHS model, with a different transformer and light source. Extremely functional.
- The dust proof illuminating system keeps the light path clean.

LS20H Lamp Housing

Encloses a precentered 6V 20W halogen bulb.



Standard Outfits

Module			BHT		
			111	112	312
Microscope Stand		BHT-F	○	○	○
Revolving Nosepiece	Quintuple	BH2-5RE	○	○	○
Observation Tube	Binocular, 30° Inclined	BH2-BI30	○	○	
	Trinocular, 30° Inclined	BH2-TR30			○
Mechanical Stage	Graduated	BH2-SVR	○	○	○
Condenser	Top Lens Swing-out/in	BH2-SC			○
	Abbe	BH2-CD	○	○	
Lamp Housing		LS20H	○	○	○
Bulb	6V 20W Halogen	6V20W HAL(2pcs.)	○	○	○
Power Cord		UYCP	○	○	○
Objective	D Achromat	4X	○		
		10X	○		
		40X	○		
		100X oil	○		
	D Plan Achromat	4X		○	○
		10X		○	○
Eyepiece	Viewing, Widefield, HEP	WHK10X (2pcs.)	○	○	○
	For photomicrography	NFK 3.3XLD			○

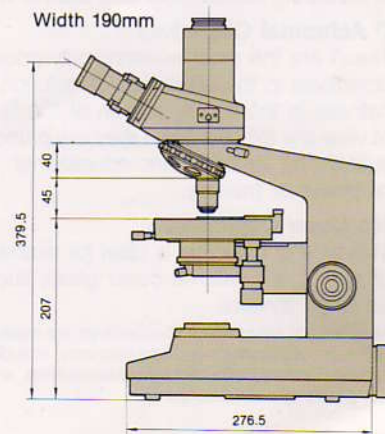

LB (Long Barrel) Objectives

The LB (Long Barrel) Series ranges from inexpensive objectives to top quality and special-purpose objectives. This extensive selection enables the user to choose the ideal lens for the purpose intended.

In the design of LB objectives, OLYMPUS has drawn upon its extensive and renowned expertise in optical technology. The objectives offer the following features:

1. High resolution
2. Superior contrast
3. Excellent field flatness
4. F.N. 20 widefield observation (with WHK10X eyepiece)
5. Ultra-low magnification objectives are parfocal with high-magnification lenses.

S Plan Apochromat Objectives

These objectives are of the highest quality design. Chromatic aberration is thoroughly compensated, field flatness is superb and the high numerical aperture provides outstanding resolution.

S Plan Achromat Objectives

The S Plan objectives are the most popular high quality objectives in the LB series. Excellent optical correction across the entire lens surfaces makes them ideally suited for use in differential interference contrast microscopy and for super widefield observation.

S Plan FL Objectives

The ultra low magnifications (1X, 2X) of these objectives make them ideal for examination of large specimen areas. They are fully parfocal with other LB objectives. The SPlanFL2X objective is suitable for super widefield observations.

Note: These objectives perform best with the BH2-ULC ultra-low condenser.

D Plan Achromat Objectives

With D Plan objectives, field flatness is guaranteed up to F.N. 20. Ideal for photomicrographic purposes, they are widely used in research, educational and routine work.

D Achromat Objectives

These are the most economically priced objectives in the LB series. Resolution and flatness in the center portion of the field of view are excellent and they are particularly suitable for routine work, educational purposes or training.

No Cover Objectives

This type of objective is ideal for examination of specimens with no cover glass, such as blood smears.

*A variety of other types of objectives are available for different applications and requirements, including phase-contrast, reflected light fluorescence, or polarized light microscopy.



S Plan Apochromat



S Plan Achromat



D Plan Achromat



D Achromat



No Cover

Eyepieces and Condensers

To complement the performance of our LB objectives, an extensive range of eyepieces and six types of condensers are available. To exploit the full performance of objectives with magnifications from 1X to 100X requires the choice of the proper condenser.



WHK/NK Eyepieces

NFK Photo Eyepieces

LB Series Eyepieces

Designed for use with LB Series objectives, WHK eyepieces are easy and comfortable to use and are of widefield design (F.N. 20 with the WHK10X eyepiece). The high eye point makes them easy to use by persons who wear glasses and enables fatigue-free observation over long periods of time. Other eyepieces in the series include the WHK8X, WHK15X, NK5X and NK20X.

NFK Series Photo Eyepieces

These photo eyepieces are specifically designed for photomicrography. They are available in 1.67X, 2.5X, 3.3X, 5X and 6.7X magnifications. NFK 1.67X is recommended to be used with TV camera.

Condensers

An extensive range of condensers is available, covering brightfield and darkfield observations.

The BH2-AAC is a top quality achromatic aplanatic brightfield condenser which permits full compensation for all aberrations. The swing-out BH2-SC condenser is suitable for a wide range of magnifications. Several other condensers are available, including the general-purpose BH2-CD and the BH2-ULC for ultra-low magnification.



	BH2-AAC	BH2-SC	BH2-CD	BH2-ULC	BH2-DCW	BH2-DGD
	Achromatic/Aplanatic Condenser	Swing-out Condenser	Abbe Condenser	Ultra Low Condenser	Immersion Darkfield Condenser	Dry Darkfield Condenser
N.A.	1.40	0.9—0.16	1.25	0.16	1.40—1.20	0.92—0.80
Focal Length	9mm	12mm	13.4mm	67.4mm	7.65mm	11.8mm
Optical Construction	7 elements in 4 groups	4 elements in 3 groups	2 elements in 2 groups	3 elements in 3 groups	2 elements in 1 group	1 element in 1 group
Objective Power	10X—100X (S.W.)	2X—100X (S.W.)	4X—100X (S.W.) 10X—100X	1X—4X (S.W.) 2X—4X	10X—100X	10X—40X
Aperture Iris Diaphragm	○	○	○	○	—	—

Observation Tubes

All BH2 series observation tubes have constant tube length adjustment. This feature automatically maintains the optimum observation conditions when interpupillary distance is varied, without requiring troublesome adjustments.

BH2-BI30 Binocular Observation Tube

The BH2-BI30 is designed exclusively for visual observation.

Inclination: 30° to the horizontal
 Interpupillary distance: 53—75mm (with constant tube length adjustment)
 Maximum F.N.: 21

BH2-TR30 Trinocular Observation Tube

This tube increases the efficiency of photographic work since it permits camera focusing through the binocular section. The three-step light path selector allows photomicrography and observation at the same time.

Inclination: 30° to the horizontal
 Interpupillary distance: 53—75mm (with constant tube length adjustment)
 Maximum F.N.: 21

BH2-SW Super Widefield Attachment

The BH2-SW attachment presents the observer with a field of view about twice the size of that obtained with ordinary observation tubes, and thus reduces to a minimum the need to move the specimen around. This results in a significant increase in work efficiency. The 3-step light path selector and constant tube length adjustment allow camera focusing through the binocular section for photomicrography.

Inclination: 30° to the horizontal
 Interpupillary distance: 56—75mm (with constant tube length adjustment)
 Maximum F.N.: 26.5

Standard Outfits

	Module	BH2-SW	
		-1	-2
SW Trinocular Tube	BH2-SWTR30	<input type="checkbox"/>	<input type="checkbox"/>
SW Eyepiece	SWHK10X (2pcs.)	<input type="checkbox"/>	<input type="checkbox"/>
Photo Eyepiece	NFK3.3XLD	<input type="checkbox"/>	<input type="checkbox"/>
S Plan Achromatic Objective	SPlan4X	<input type="checkbox"/>	<input type="checkbox"/>
	SPlan10X	<input type="checkbox"/>	<input type="checkbox"/>
	SPlan20X	<input type="checkbox"/>	<input type="checkbox"/>
	SPlan40X	<input type="checkbox"/>	<input type="checkbox"/>
	SPlan100X	<input type="checkbox"/>	<input type="checkbox"/>

BH2-PT Vertical Phototube

This tube presents the most economical way of conducting photomicrography. The binocular observation tube must be removed in order to attach the vertical phototube and so observation is not possible at the same time as photomicrography.



BH2-BI30



BH2-PT



BH2-TR30

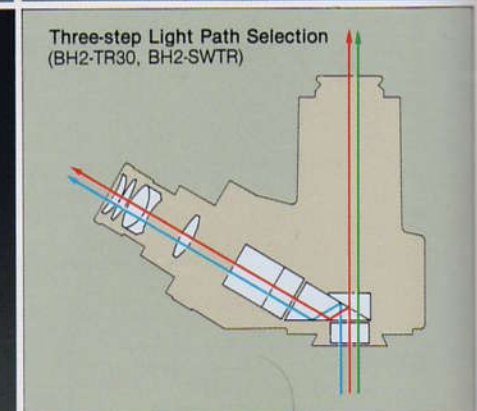

	V	CV	C
Observation	100%	20%	—
Photomicrography	—	80%	100%



BH2-SW-2

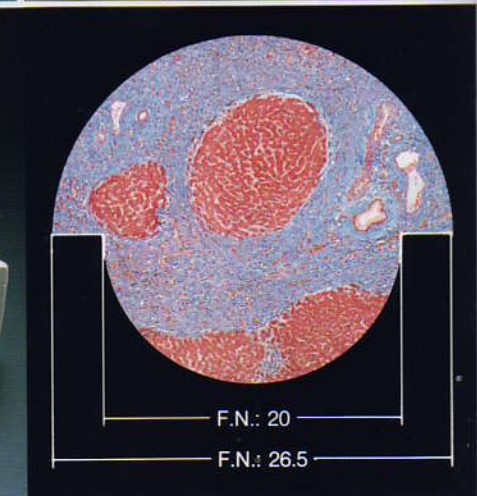

F.N.: 20

F.N.: 26.5

Stages

A selection of stages is available, including those suitable for differential interference contrast and fluorescence microscopy.



BH2-SVR



BH2-SVL



BH2-SH



BH2-SRG



BH2-SVFR



Specimen Holders

BH2-SVR Mechanical Stage with Right-Hand Low Drive Controls

This is the most popular stage for many areas of research and testing. Covered ball races prevent contamination by dust and glass chips. Scanning area is 76mm (X) × 50mm (Y). A 270° rotation capability makes this stage highly suitable for photographic framing and for differential interference contrast purposes.

Note: Range of rotation is reduced to 65° when a differential interference contrast condenser is attached.

BH2-SVL Mechanical Stage with Left-Hand Low Drive Controls

Has the same features as the BH2-SVR, except that the controls are located on the left.

BH2-SH Mechanical Stage with Horizontal Drive Controls

The stage controls are horizontally located on the left- and right-hand sides. The stage can be rotated through 40° when the stage control knobs are on the far side, and through 180° when on the near side.

BH2-SRG Circular Rotatable Stage

This is the ideal stage for Nomarski differential interference contrast and polarized-light microscopy. It features a centering mechanism, and graduations at 1° intervals around the entire circumference. Stage diameter is 142mm. It accepts stage clips or KM and FM attachable mechanical stages.

BH2-SVFR Grooved Mechanical Stage with Right-Hand Low Drive Controls

The fluted design prevents slides sticking to the stage surface due to spilled immersion oil, thus eliminating interruptions in microscopic work. The X-axis excursion is 52mm, and Y-axis excursion is 76mm. The stage rotates through 270°.

BH2-PC/BH2-PCD Phase Contrast Attachment

BH2-KPC Simple Phase Contrast Attachment

Phase-contrast is one of the most commonly used techniques in microscopy. It is employed in the examination of living micro-organisms, cells, etc., permitting observation of the internal structures of such specimens under different degrees of contrast.

BH2-PC/BH2-PCD* Phase Contrast Attachment

- Features an Abbe-type turret condenser with a numerical aperture of 1.25.
- Incorporates annular phase plate for 10X, 20X*, 40X and 100X phase objective.
- Incorporates an aperture diaphragm for use in brightfield. This diaphragm is automatically disengaged in phase-contrast observation.
- The CT-5 centering telescope with high eye point permits simple and accurate annulus alignment.
- The BH2-SW super widefield attachment use in conjunction with S Plan phase-contrast objectives enables observation of super widefield phase contrast images.
- Four types of contrast—PL, PLL, NH and NM—are available.

Two types of objectives are available for phase-contrast microscopy: S Plan Achromats and D Achromats. They come in magnifications of 10X, 20X*, 40X and 100X, and in both positive and negative contrast.

S Plan Achromat	PL	10X, 20X*, 40X, 100X
	NH	10X, 20X*, 40X, 100X
D Achromat	PL	10X, 20X*, 40X, 100X
	PLL	10X, 20X*, 40X, 100X
	NH	10X, 20X*, 40X, 100X
	NM	10X, 20X*, 40X, 100X

*PL = Positive Low
NH = Negative High
PLL = Positive Low-Low
NM = Negative Medium
* 20 objective can not be adapted to the BH2-PCD model.

BH2-KPC Simple Phase Contrast Attachment

Used in conjunction with a BH2-CD brightfield condenser and phase contrast objectives, this attachment presents phase contrast images easily and economically. Available in 10X, 20X and 40X magnifications.



BH2-PC-PB1

BH2-PC Standard Outfits

Module		BH2-PC							
		PA-1	PA-2	PB-1	PB-2	PB-3	PB-4	PB-5	PB-6
Phase Contrast Turret Condenser* N.A. 1.25	BH2-PC	○	○	○	○	○	○	○	○
Centering Telescope	CT-5	○	○	○	○	○	○	○	○
Phase Contrast Objective Set	PC S Plan Achromat	10X, 20X, 40X, 100X oil PL	○		○				
		10X, 20X, 40X, 100X oil NH	○			○			
	D Achromat	10X, 20X, 40X, 100X oil PL		○			○		
		10X, 20X, 40X, 100X oil PLL		○				○	
		10X, 20X, 40X, 100X oil NH		○					○
	10X, 20X, 40X, 100X oil NM		○					○	

•IF550 Interference filter included



BH2-PCD-PA-1

BH2-PCD Standard Outfits

Module		BH2-PCD							
		PA-1	PA-2	PB-1	PB-2	PB-3	PB-4	PB-5	PB-6
Phase Contrast Turret Condenser* N.A. 1.25	BH2-PCD	○	○	○	○	○	○	○	○
Centering Telescope	CT-5	○	○	○	○	○	○	○	○
Phase Contrast Objective Set	PC S Plan Achromat	10X, 40X, 100X oil PL	○		○				
		10X, 40X, 100X oil NH	○			○			
	D Achromat	10X, 40X, 100X oil PL		○			○		
		10X, 40X, 100X oil PLL		○				○	
		10X, 40X, 100X oil NH		○					○
	10X, 40X, 100X oil NM		○					○	

•IF550 Interference filter included

The BH2-UCD is a powerful universal condenser that is adaptable with the BH2-UCD by changing the optical elements a variety of features between the different condenser types contrast, Apochromat, DIC and Köhler illumination methods. The flexibility for component adaptation in the BH2-UCD is optimum for advanced research applications of various microscopy methods.



Fibroblast (human embryo). SPlan20XPL, NFK2.5XLD

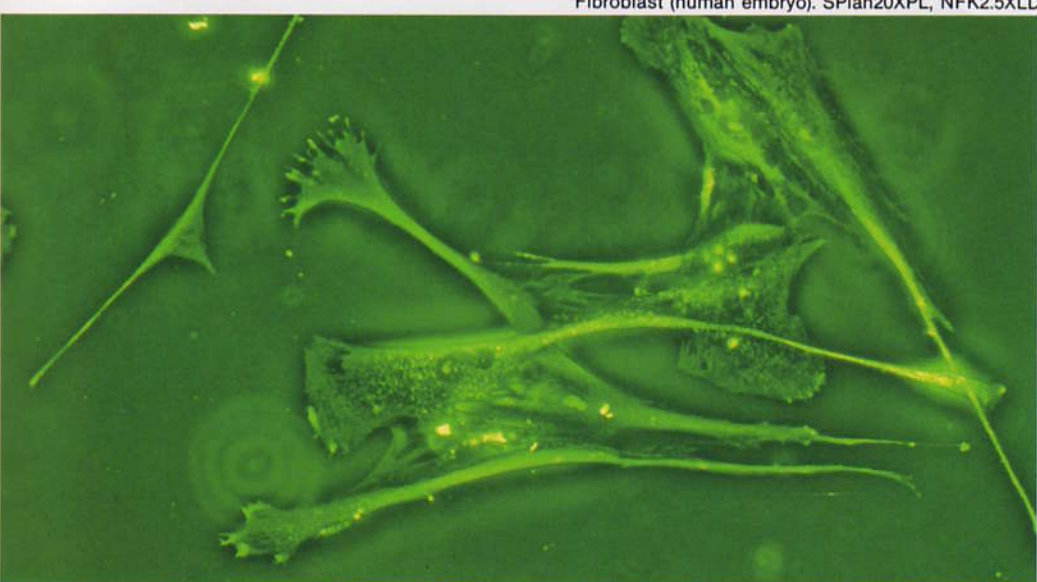

Fibroblast (human embryo). SPlan20XNM, NFK2.5XLD



PC S Plan Achromat PL



PC S Plan Achromat NH



PC D Achromat PL



PC D Achromat PLL



PC D Achromat NH



PC D Achromat NM



BH2-KPC-1

BH2-KPC Standard Outfits

Module		BH2-KPC	
		1	2
Abbe Condenser	BH2-Cd	○	
Green Filter	45G533	○	○
Phase annular ring	BH2-PC10RS	○	○
	BH2-PC20RS	○	○
	BH2-PC40RS	○	○
Phase Contrast Objective	PCD10XPL	○	○
	PCD20XPL	○	○
	PCD40XPL	○	○
Centering Telescope	CT-5	○	○

BH2-UCD Universal Condenser

The BH2-UCD is a powerful universal condenser that is compatible with diverse microscopic techniques. Simply by changing the optical elements, a speedy changeover is possible between the brightfield, darkfield, phase contrast, Nomarski differential interference contrast (DIC) and polarizing observation methods. Its flexibility for combining different observations establishes the BH2-UCD as optimum for advanced research applications that require a combination of various microscopy methods.

- Specially designed for use with the BH-2 Series of System Microscopes, the BH2-UCD allows for observations under transmitted light illumination.
- Simply by replacing the optical element, the BH2-UCD permits a smooth and quick changeover between various microscopic techniques, thus performing the combined microscopy that meets your particular application.



- The BH2-UCD may be combined with the BH2-RFCA reflected light fluorescence illuminator, the BH2-NA Nomarski DIC intermediate tube, the BH2-KPA simple polarizing intermediate tube and other attachments provided with the BH-2 Series microscopes.
- The BH2-UCD employs a top lens swing-out system, enabling use of 2x through 100x magnification objectives.
- When combined with a reflected light fluorescence attachment, reflected light fluorescence microscopy and phase contrast or Nomarski DIC observation can be performed simultaneously.

Standard Configurations

Module	Item	BH2-UCD					
		1	2	3	4	5	6
BH2 Universal Condenser Main Body (w/43IF550-W45)	BH2-UCD	○	○	○	○	○	○
Optical Accessories	Phase Contrast Ring Attachment for 10x Objective				○	○	○
	Phase Contrast Ring Attachment for 20x Objective				○	○	○
	Phase Contrast Ring Attachment for 40x Objective				○	○	○
	Phase Contrast Ring Attachment for 100x Objective				○	○	○
	Nomarski Prism for SPlan 10x Objective	○	○		○	○	○
	Nomarski Prism for SPlan 20x Objective	○	○		○	○	○
	Nomarski Prism for SPlan 40x Objective	○	○		○	○	○
	Nomarski Prism for SPlan Apo 60x (oil) Objective	○	○		○	○	○
	Nomarski Prism for SPlan 100x or DPlan Apo 100x UV. Objective	○	○		○	○	○
	Nomarski Prism for DPlan Apo 10x UV. Objective			○	○	○	○
	Nomarski Prism for DPlan Apo 20x UV. Objective			○	○	○	○
	Nomarski Prism for DPlan Apo 40x UV. (dry) Objective			○	○	○	○
	Nomarski Prism for DPlan Apo 40x UV. (oil) or DApo 40x UV. (oil) Objective			○	○	○	○
Darkfield Ring Attachment	BH2-UDA					○	
Nomarski DIC Intermediate Tube (for Transmitted Light)	BH2-NA	○	○		○	○	
Analyzer (for Reflected Light Fluorescence Attachment)	BH2-ANF			○		○	
Nomarski Slider (for Reflected Light Fluorescence Attachment)	BH2-NAF			○		○	
Centering Telescope	CT-5				○	○	
Objectives	SPlan 10x, 20x, 40x SPlan 100x oil	○					

- ★ All the elements listed above, except those marked with "○" are optional.
- ★ Combination "3" in the above table is for use with a reflected light attachment.

Optical Elements and Compatible Objectives

Optical Element	Compatible Objectives
Phase Contrast Ring Attachment	URS10 PCSPlan 10x, PCDAch 10x, DPlan Apo 10xUN-PL
	URS20 PCSPlan 20x, PCDAch20x, LWDCDPlan20xPL, ULWDCDPlan20xPL
	URS40 PCSPlan40x, PCDAch40x, DPlan Apo20xUV-PL, LWDCDPlan40xPL, ULWDCDPlan40xPL
	URS100 PCSPlan100x (Oil), PCDAch 100x (Oil), DPlan Apo40x/100xUV-PL (Oil), DAPO40x/100xUV-PL (Oil), SPlan Apo60xPL (Oil)
Nomarski Prism	UNP10 SPlan10x
	UNP20 SPlan20x
	UNP40 SPlan40x
	UNP60oil SPlan Apo60x (Oil)
	UNP100 SPlan100x (Oil), DPlan Apo 100x (Oil)
	UNPD10 DPlan Apo 10xUV
UNPD20 DPlan Apo20xUV, DPlan Apo20xUV (Oil)	
UNPD40 DPlan Apo40xUV (Dry)	
UNPD40oil DPlan Apo40xUV (Oil), DAPO40x (Oil)	
Darkfield Ring Attachment	UDA SPlan10x/20x/40x, SPlan Apo10x/20x, NCSPPlan40x, EDAch10x/40x, DAch 10x/20x/40x, DPlan10x/20x/40x, DPlan50x (Oil), DPlan Apo10x/20xUV, LWDCDPlan20x/40x, ULWDCDPlan20x/40x

Specifications

Item	Description
Applicable microscope	BHS, BHT
Type	Achromatic/aplanatic condenser, top lens swing-out type
Numerical Aperture (N.A.)	0.9 (top lens IN)/0.2 (top lens OUT)
Applicable slide thickness	0.9—1.4mm
Working distance	1.5mm (with 1.2mm slide)
Illuminating area	φ3mm (top lens IN)/φ14mm (top lens OUT)
Focal length	13.1mm (top lens IN)/229mm (top lens OUT)
Turret	Upper turret
	Lower turret
Aperture iris diaphragm	Quintuple, optical elements may be attached
Mounting	Twin, aperture iris diaphragm with 360° rotatable polarizer
Dimensions	φ2.8—φ21mm
Mounting	Detachable circular dovetail, clamped with clamping screw
Dimensions	105 (turret φ)×59 (height)mm
Weight	550g (1.21 lb)



1. Fetal fibroblast. Phase-contrast.
2. A rat oocyte at metaphase of cell division II of meiosis. Nomarski DIC.
3. A rat placenta at 15th day of gestation. (3-a) Brightfield, (3-b) Darkfield.

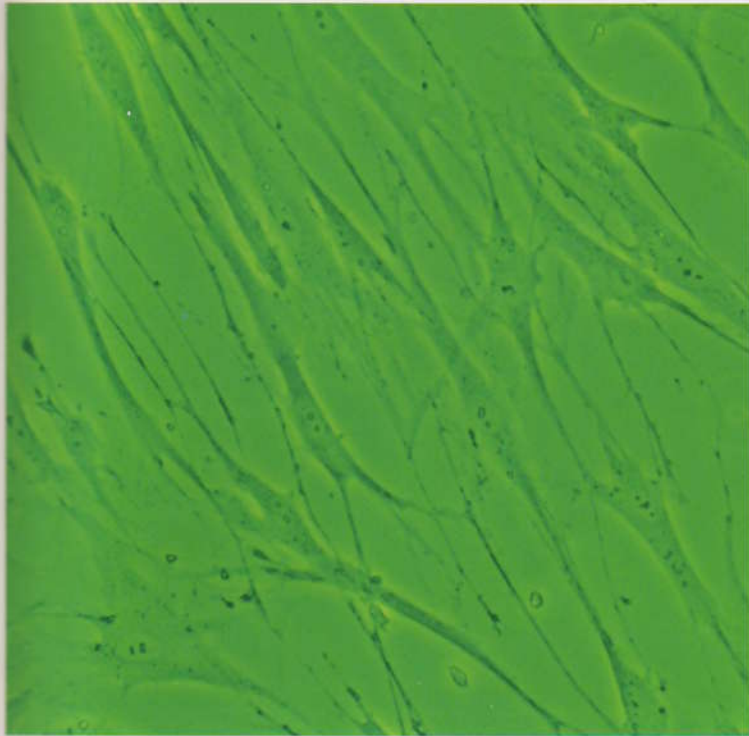

1

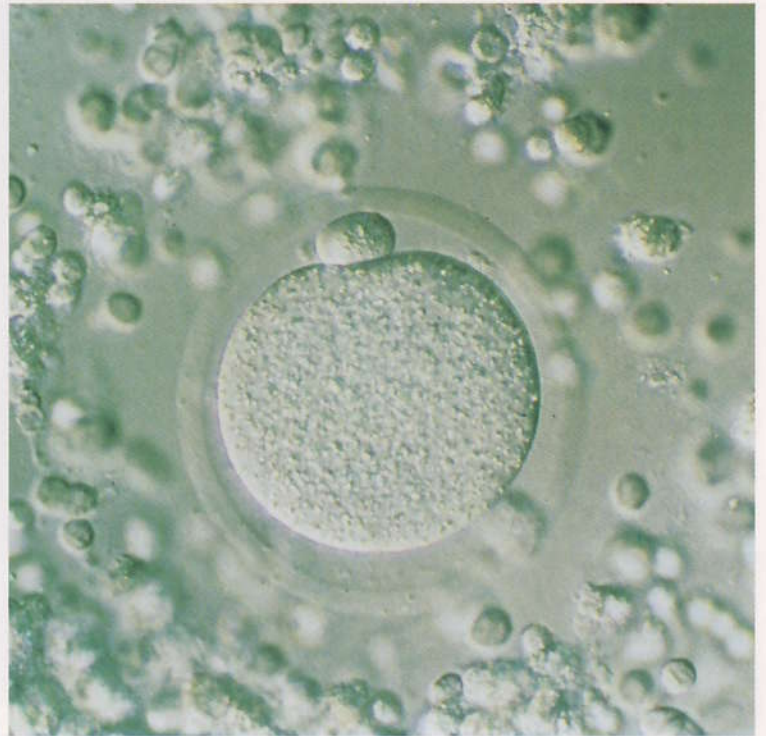

2

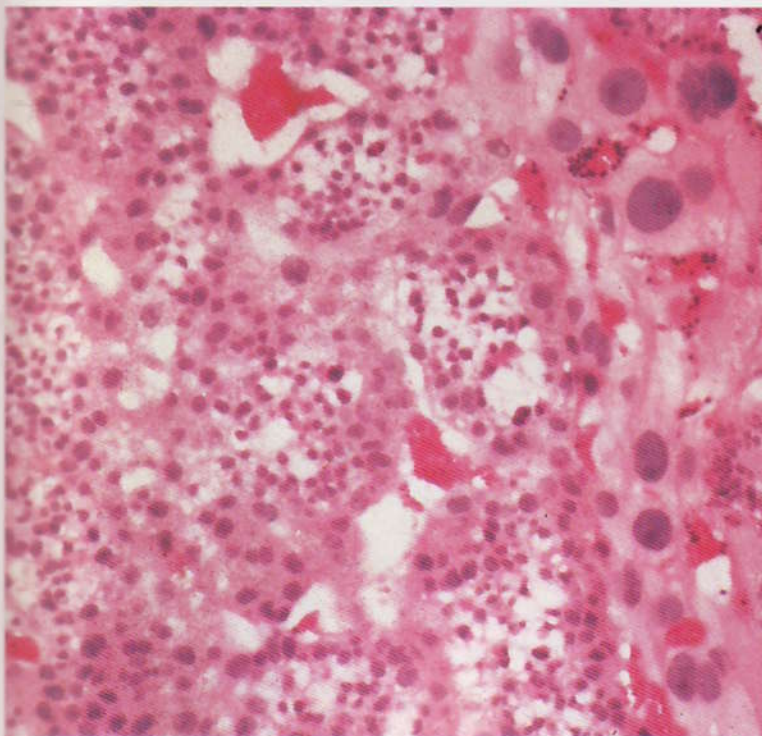

3-a

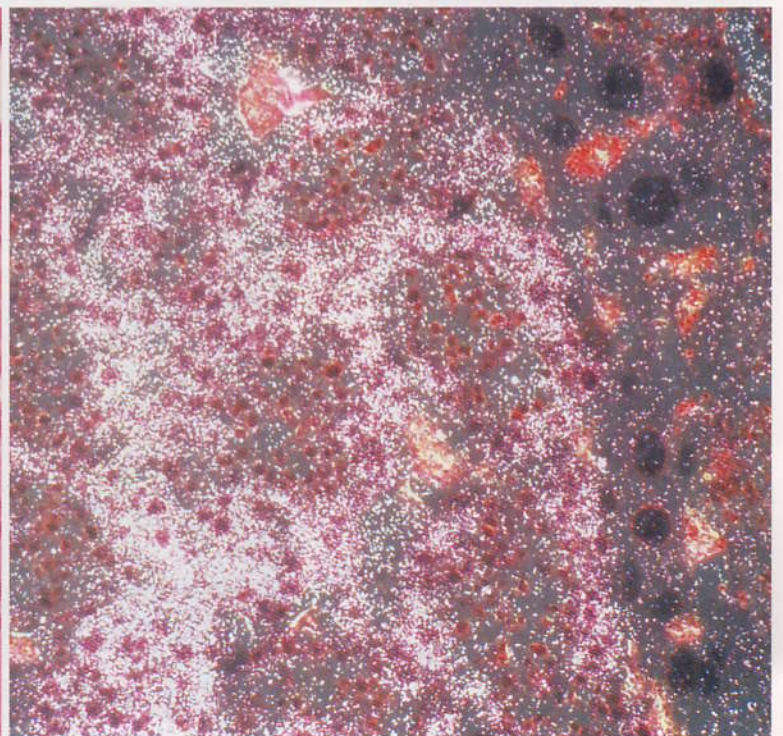

3-b

BH2-RFC Reflected Light Fluorescence Attachment

Reflected light fluorescence attachment expands scope of research through flexible combinations and simple switchover of multiple observation methods.

Illuminator

- Three levels of exciting light intensity are available: 100%, 25% and 0%
- An aperture diaphragm allows the precise regulation of exciting light intensity and fluorescence image contrast.
- Features a built-in field diaphragm with centering mechanism. This feature eliminates stray light which causes flares and reduces image clarity.

Cube Unit System

- Six cubic units are available for U, V, BV, B, G and IB excitations. Optimum cubic unit can be selected for each purpose of observation. Three of these units may be mounted simultaneously.
- A fluorescent cubic unit with built-in dichroic mirror, exciter and barrier filters accepts an additional barrier filter and a supplementary exciter filter. This allows the band to be adjusted for excitation. The exciter and barrier filters may also be replaced, giving the user greater flexibility.
- The IB excitation combination employs a newly developed dichroic mirror that produces exceptionally bright fluorescent images, and an interference barrier filter. This provides greater contrast when observing FITC-stained specimens than does the B excitation combination, meaning that it is possible to observe weakly fluorescing materials.
- The newly developed BH2-HMIGS unit enables IGS observation to be made when it is used in combination with D Plan Apo 40x/UV/100XUV objectives.

BH2-RFC-7

A reflected light fluorescence attachment with halogen light source, designed for B excitation.

D Plan Apo UV Series

- This Series objectives feature an apochromatic design to correct chromatic aberrations over a wide wavelength range. This design guarantees a sharp image and bright illumination in any excitation.

D Plan Apo UVPL Series

Olympus also offers a lineup of 4 types of fluorescent phase contrast objectives. When reflected light fluorescence and transmitted light phase contrast observation are performed simultaneously, an entire specimen image, including the non-fluorescent area, can be obtained.

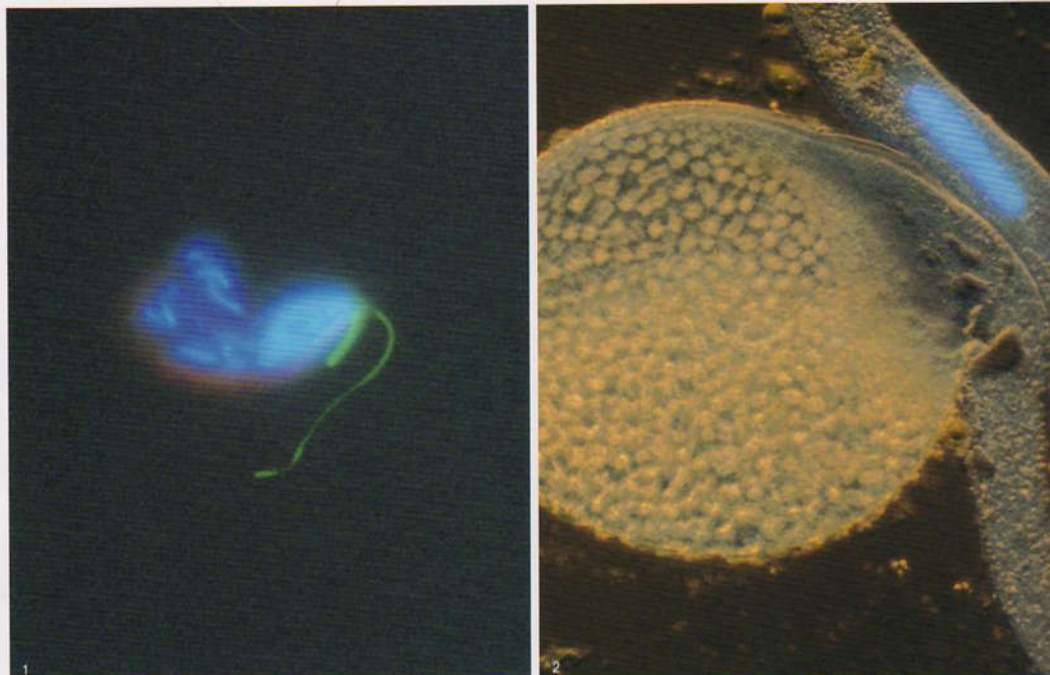

1. Zoonospores of physarum polycephalum; triple fluorescence-stained image (DAPI + Rhodamine-bonded phalloidin = FITC anti-tubulin antibody). DPlan Apo 100x, NFK5xLD
2. Nuclei in the pollen tube of a lillium longiflorum; Nomarski DIC/fluorescent image. DPlan Apo 40x, NFK5xLD
Photo courtesy of Dr. Tsuneyoshi Kuroiwa, University of Tokyo, Faculty of Science.



BH2-RFC-1

BH2-RFC Standard Outfits

		Item	BH2-RFC						
			-1	-2	-3	-4	-5	-6	-7
Fluorescence Illuminator, including UV Protective Shield, Immersion Oil 50cc and Dust Cover B071		BH2-RFCA	○	○	○	○	○	○	○
Fluorescence Lamp Housing		BH2-LSRF-2	○	○	○	○	○	○	
Power Supply		BH2-RFL-T3	○	○	○	○	○	○	
Mercury Burner (2 pcs.)		USH-102D	○	○	○	○	○	○	
Halogen Lamp Housing		BH2-LSRH80/50							○
Transformer		TH3							○
Halogen Bulb (2 pcs.)		JC12V50WHAL-L							○
Power Cord		UYCP	○	○	○	○	○	○	○
Centering Screen		BH2-SGRF	○	○	○	○	○	○	
Dichroic Mirrors Assembly	U Excitation	BH2-DMU	○						
	V Excitation	BH2-DMV	○						
	BV Excitation	BH2-DMBV	○						
	B Excitation	BH2-DMB		○	○			○	○
	G Excitation	BH2-DMG		○	○			○	○
Brightfield Cube	IB Excitation	BH2-DMIB	○						
		BH2-BF	○	○	○	○	○	○	○
Supplementary Exciting filter	B Excitation	20EY455-W22		○	○			○	○
	IB Excitation	20EY475-W22		○		○			
	G Excitation	20EO515-W22		○	○			○	
	BV Excitation	20EL420-W22		○	○				
Supplementary Barrier Filter	U Excitation	20L435-W22	○						
	V Excitation	20Y455-W22	○						
	V, BV Excitation	20Y495-W22	○						
		20O515-W22	○						
	B, IB Excitation	20B460-W22	○	○	○			○	○
		20G520-W22				○			
		20O530-W22	○	○	○			○	○
Objective (for reflected light fluorescence)		20O570-W22	○	○	○			○	○
		20O590-W22	○	○	○			○	○
		20R610-W22	○	○	○			○	○
		DPLAPO10XUV	○	○	○	○			
		DPLAPO20XUV/Oil	○	○	○	○			
		DPLAPO40XUV/ Spring, Iris, Oil	○						
	DPLAPO100XUV/ Spring, Iris, Oil	○							
	DAPO40XUV/ Spring, Iris, Oil		○	○	○				
	DAPO100XUV/ Spring, Iris, Oil		○	○					

U Excitation

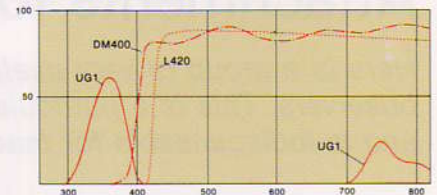

V Excitation

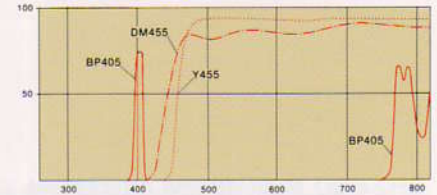

BV Excitation

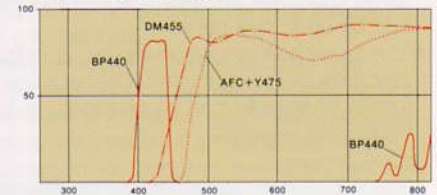

B Excitation

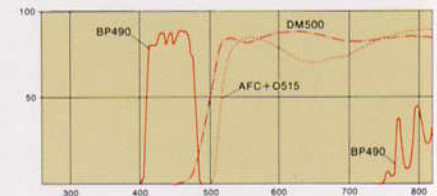

G Excitation

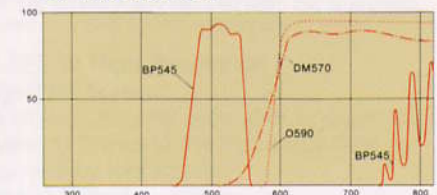

IB Excitation

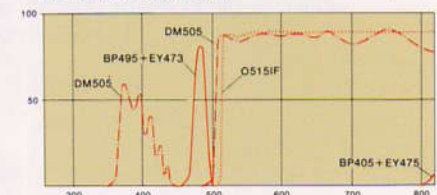

Barrier Filters

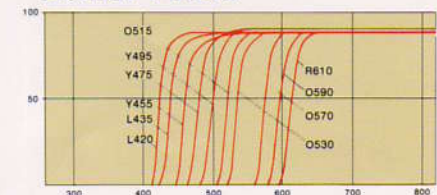

FITC Interference Filter Set



(Transmitted light)

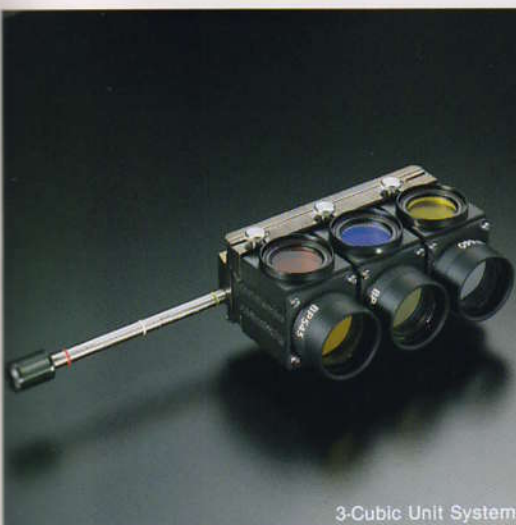

3-Cubic Unit System

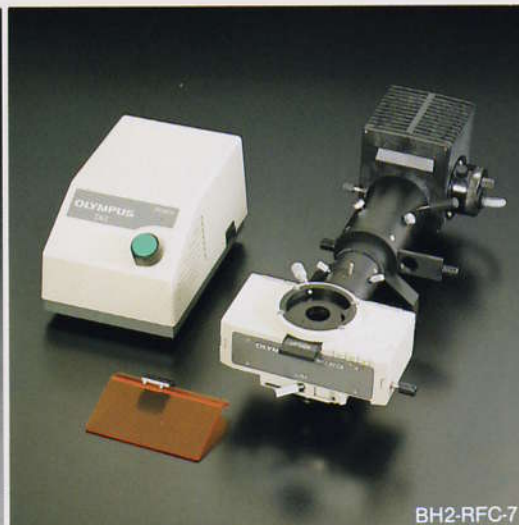

BH2-RFC-7



D Plan Apo UV Series



D Plan Apo UVPL Series

Attachments for Group Observation

Here is a group of very useful accessories which allow simultaneous viewing by several observers. This is a particularly convenient feature for discussions between researchers, and is indispensable for teaching purposes.

BH2-MDO Multi-viewing Attachment

- Permits simultaneous observation of the same specimen image in the same orientation by up to five persons.
- The arrow pointer can be moved to indicate any area of the specimen. Pointer color (green or orange) can be changed, and brightness adjusted.

Standard Outfits

Module		BH2-MDO	
		1	2
Multi-viewing body	BH2-MDO-B	1pc	1pc
Optical relay unit	BH2-MDO-SV	2pcs	1pc
Binocular tube	BH2-BI30	4pcs	2pcs
Transformer for pointer illumination	T-DO	1pc	1pc
Widefield eyepieces	WHK10X	4pcs	2pcs
	WHK10X-H	4pcs	2pcs



BH2-MDO

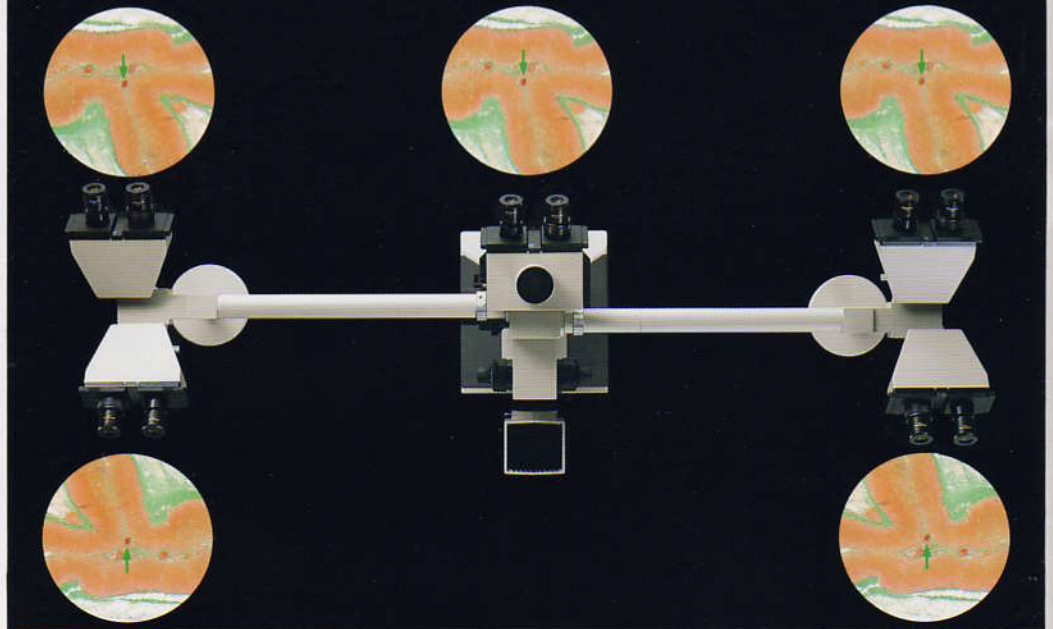



BH2-DO

BH2-DO Dual-viewing Attachment

- The features are exactly the same as the BH2-MDO, except that it permits observation by two persons.
- There is ample distance between the observer positions, allowing relaxed viewing.
- The second observer may manipulate the pointer by means of an additional lever located on the opposite side from the main lever.

Standard Outfits

Module	BH2-DO-1
Dual viewing body	BH2-DO-B <input type="radio"/>
Binocular tube	BH2-BI30 <input type="radio"/>
Transformer for pointer illumination	T-DO <input type="radio"/>
Widefield eyepieces	WHK10X <input type="radio"/>
	WHK10X-H <input type="radio"/>
Heat screen*	BH2-DO-HPS <input type="radio"/>

*The heat screen is only required when this attachment is used on a BHS System microscope.

AH-SPS-W High Resolution Projection Screen

Eye strain is minimal even after long periods of viewing thanks to the high resolution presented by this screen.

Effective diameter: 155mm

Screen image magnification: Objective magnification \times NFK photo eyepiece magnification $\times 3$



AH-SPS-W

PM-10ADS/PM-10AD Photomicrographic and Cinemicrographic Systems

These fully automatic Photomicrographic systems are designed for exclusive use with microscopes. A built-in microcomputer assures easy and failure-free operation. They can also be operated manually, and both accept large format film.

PM-10ADS Automatic Photomicrographic System

- Features both spot (1%) and integrated (30%) metering.
- The built-in microcomputer automatically compensates for a film's reciprocity failure characteristics and controls exposure time correctly even during long exposures.
- An exposure adjustment feature allows the precise control of exposure time to match the specimen's characteristics.
- Incorporates an AE lock mechanism, useful when trimming with spot metering or to keep density uniform in continuous panoramic photography.
- Manual exposure control is also available.
- Accepts the following types of film: 35mm; 4" x 5" sheet; and 3 1/4" x 4 1/4" Polaroid.
- The multiple exposure mechanism enables a number of images to be recorded on the same frame of film.

PM-10AD Automatic Photomicrographic System

Has the same features as the PM-10ADS except that it provides only 60% metering with 35mm film.

Note: This system accepts practically all the accessories available for the PM-10ADS.

PM-CTR Color Temperature Module

The PM-CTR measures color temperatures from 2,500K to 10,000K. It provides greater accuracy in color temperature readings.

PM-VSB Brightframe viewfinder

This viewfinder is optionally available for the Olympus Photomicrographic Systems PM-10ADS and PM-10AD.

Focusing on the double crosslines and the film format frames when photographing dark specimens against a dark background is greatly facilitated by the fact that the frame reticle is illuminated and the color of the frame can be varied from black to red or yellow.



PM-10ADS + BH2-RFC



PM-10AD



PM-CTR



PM-VBS



4" x 5"



3 1/4" x 4 1/4"
Polaroid®

PM-10ADS Standard Outfits

Module		PM10-		
		35ADS-2	L1ADS-2	L2ADS-2
Automatic Exposure Body	PM-PBSP	○	○	○
Automatic Exposure Control Unit	PM-CBSP	○	○	○
Power Cord	UYCP	○	○	○
Adapter for 35mm Camera Back	PM-D35A	○		
Adapter for Large Format Camera Back	PM-DL-W		○	○
35mm Camera Back	C-35AD-4	○		
4" x 5" Intermediate Adapter	PM-C4 x 5-W		○	
3-1/4" x 4-1/4" Polaroid Camera Back	PM-CP-W			○
Focusing Telescope	PM-VSP	○	○	○
Focusing Magnifier	PM-FT-36	○	○	○
Color Temperature Module	PM-CTR	○	○	○
Filter Set	PM-FIL-C	○	○	○

PM-10AD Standard Outfits

Module		PM10-		
		35AD-1	L1AD-1	L2AD-1
Automatic Exposure Body	PM-PBS	○	○	○
Automatic Exposure Control Unit	PM-CBAD	○	○	○
Power Cord	UYCP	○	○	○
Adapter for 35mm Camera Back	PM-D35A	○		
Adapter for Large Format Camera Back	PM-DL-W		○	○
35mm Camera Back	C-35AD-4	○		
4" x 5" Intermediate Adapter	PM-C4 x 5-W		○	
3-1/4" x 4-1/4" Polaroid Back	PM-CP-W			○
Focusing Telescope	PM-VS	○	○	○
Focusing Magnifier	PM-FT-36	○	○	○
Adapter for NFK Photoeyepiece	PM-ADF			
Color Temperature Module	PM-CTR			
Time Lapse Control Unit	PM-IV			
Filter Set	PM-FIL-C	○	○	○

BH-10ADS/PM-10AD Photomicrographic and Cinemicrographic Systems

These fully automatic photomicrographic systems are designed for exclusive use with microscopes. They are microcomputer assisted easy and safe-to-use systems. They can also be operated manually and accept large-format film.

BH2-KP Simple Polarizing Attachment

This attachment enables polarized-light microscopy using ordinary LB objectives. A tint plate and other compensators can be used with it.

Standard Outfits

Module	BH2-KP
Intermediate tube	BH2-KPA ○
Circular Rotatable Stage	BH2-SRG ○
Tint Plate	AH-TP530-2 ○

BH-POL Polarizing Filter Set

Consisting of a polarizer and an analyzer, this accessory is useful for detecting birefringent specimen details.

BH2-CA Magnification Changer

Magnification power can be increased without changing N.A. by using this unit. This feature will greatly enhance depth of focus. Magnification can be set at three levels: 1X, 1.25X and 1.5X. The phase-contrast annuli can be aligned with the built-in Bertrand lens.

BH2-DA Drawing Attachment

Very useful in the accurate sketching of a magnified specimen image seen through the microscope. Adjustable magnification.

BH2-FH Swing-out Filter Holder

Holds three filters at one time. Filters can be exchanged at the touch of a finger, resulting in more efficient observation and photomicrography.



BH2-KP



BH-POL



BH2-CA



BH2-DA



BH2-FH



1. Candidiosis (duodenum, Grocott stain). SPlan2X, NFK2.5XLD
2. Alkaline phosphatase (liver). SPlan10X, NFK3.3XLD
3. Acid phosphatase (spleen of Gaucher's disease). SPlan10X, NFK3.3XLD
4. Nicotin amide adenine dinucleotide phosphate dehydrogenase (cell line derived from human malignant melanoma—SEK1). SPlan40X, NFK3.3XLD



1

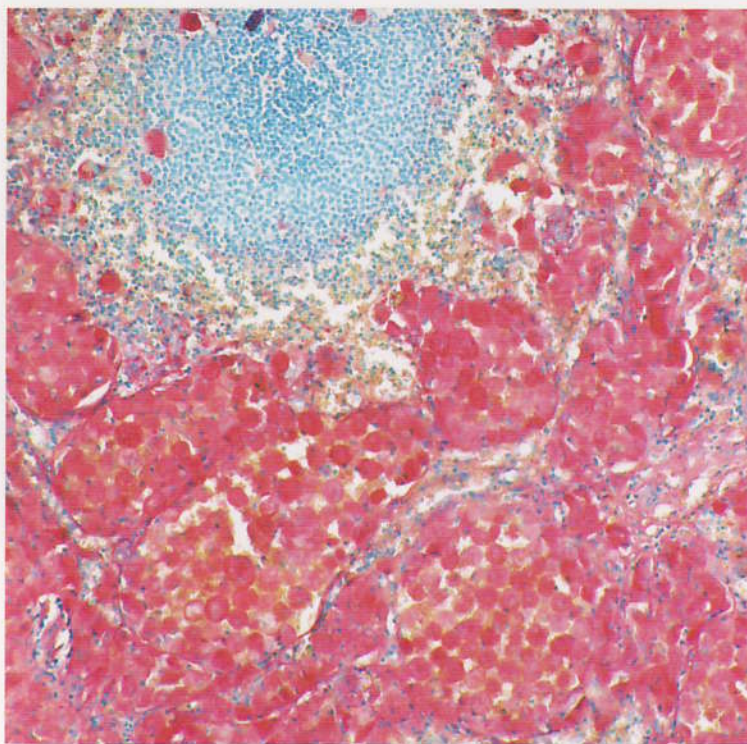

3

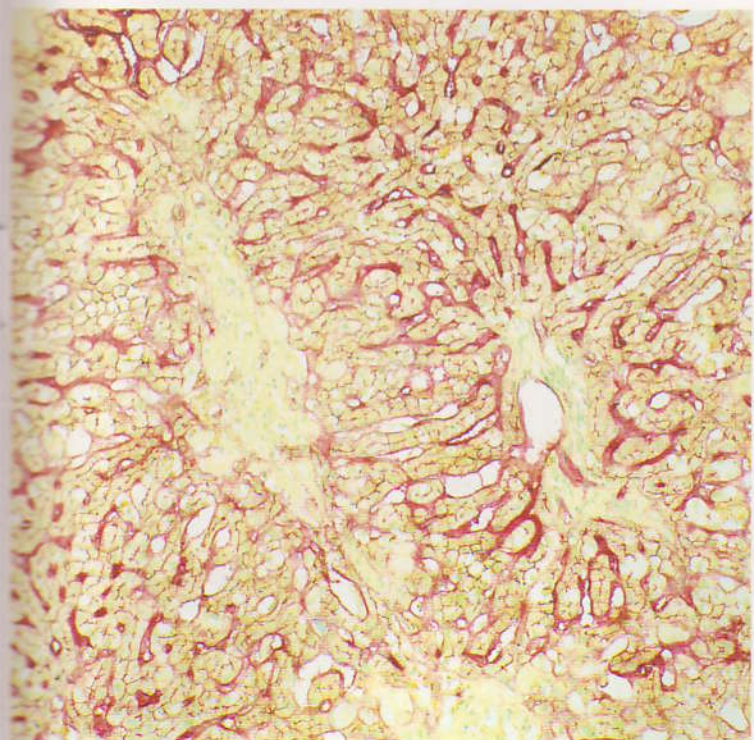

2

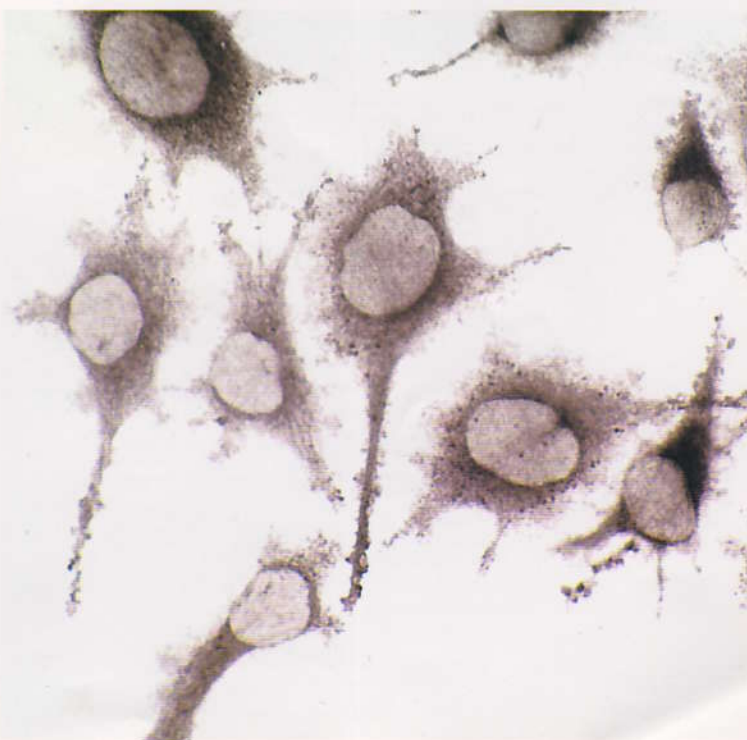

4

LB Objective Series for Biological Use

Magnification	Numerical Aperture	Working Distance mm	Focal Length mm	Remarks	
S Plan Apochromatic / D Plan Apochromatic Objectives					
S Plan Apo	4X, dry *	0.16	9.83	36.71	S.W.
	10X, dry	0.40	0.55	16.92	S.W., Spring-loaded.
	20X, dry	0.70	0.55	7.68	S.W., Spring-loaded.
	40X, dry	0.95	0.13	4.18	S.W., Correction collar ((0.11 - 0.23), Spring-loaded.
	60X, oil *	1.40	0.12	2.80	S.W., Spring-loaded.
	100X, oil	1.40	0.15	1.62	S.W., Iris diaphragm, Spring-loaded.
D Plan Apo	60X, dry	0.90	0.10	3.06	Correction collar (0.11 - 0.23), Spring-loaded.
S Plan Fluorite Objectives					
S Plan FL	1X, dry *	0.04	2.2	137.90	
	2X, dry *	0.08	5.5	73.42	S.W.
S Plan Achromatic Objectives					
S Plan	4X, dry *	0.13	15.50	36.54	S.W.
	10X, dry	0.30	7.50	18.98	S.W., D.I.C.
	20X, dry	0.46	1.50	8.03	S.W., D.I.C., Spring-loaded.
	40X, dry	0.70	0.50	4.13	S.W., D.I.C., Spring-loaded.
	100X, oil	1.25	0.17	1.69	S.W., D.I.C., Spring-loaded.
	100X, dry	0.95	0.20	1.68	S.W., D.I.C., Correction collar (0.14 - 0.20), Spring-loaded.
	D Plan Achromatic Objectives				
D Plan	4X, dry *	0.10	7.03	34.23	
	10X, dry	0.25	7.40	17.69	
	20X, dry	0.40	0.83	8.99	Spring-loaded.
	40X, dry	0.65	0.47	4.61	Spring-loaded.
	50X, oil *	0.90	0.23	3.80	Spring-loaded, Iris diaphragm.
	100X, oil	1.25	0.17	1.75	Spring-loaded.
D Achromatic Objectives					
D Ach	4X, dry *	0.10	18.23	30.03	
	10X, dry	0.25	7.18	16.90	
	20X, dry	0.40	1.63	8.63	Spring-loaded.
	40X, dry	0.65	0.63	4.58	Spring-loaded.
	60X, dry	0.80	0.23	3.14	Spring-loaded.
	100X, oil *	1.30	0.20	1.66	Spring-loaded.
Phase Contrast Objectives					
PC S Plan	4X, dry PL NH *	0.13	15.5	36.54	S.W.
	10X, dry PL NH	0.30	7.50	18.98	S.W.
	20X, dry PL NH	0.46	1.50	8.03	S.W., Spring-loaded.
	40X, dry PL NH	0.70	0.50	4.13	S.W., Spring-loaded.
	100X, oil PL NH	1.25	0.17	1.69	S.W., Spring-loaded.
PC D Ach	10X, dry PL PLL NH NM	0.25	7.18	16.90	
	20X, dry PL PLL NH NM	0.40	1.63	8.63	Spring-loaded.
	40X, dry PL PLL NH NM	0.65	0.62	4.58	Spring-loaded.
	100X, oil PL PLL NH NM *	1.30	0.20	1.66	Spring-loaded.
Objectives (for reflected light fluorescence)					
D Plan Apo	10XUV, dry	0.40	1.10	15.69	D.I.C., Spring-loaded.
	20XUV, dry	0.70	0.75	7.8	D.I.C., Spring-loaded.
	20XUV, oil *	0.80	0.18	7.78	D.I.C., Spring-loaded.
	40XUV, dry	0.85	0.25	4.04	D.I.C., Correction collar (0.11 - 0.23), Spring-loaded.
	40XUV, oil	1.00	0.16	4.34	D.I.C., Iris diaphragm, Spring-loaded.
	100XUV, oil	1.30	0.16	1.69	D.I.C., Iris diaphragm, Spring-loaded.
D Apo	40XUV, oil	1.30	0.12	4.34	D.I.C., Iris diaphragm, Spring-loaded.
	100XUV, oil	1.30	0.12	1.88	Iris diaphragm, Spring-loaded.
D Plan Apo	10XUVPL, dry	0.40	1.10	15.69	Spring-loaded.
	20XUVPL, dry	0.70	0.75	7.8	Spring-loaded.
	40XUVPL, oil	1.00	0.16	4.34	Iris diaphragm, Spring-loaded.
	100XUVPL, oil	1.30	0.16	1.69	Iris diaphragm, Spring-loaded.
D Apo	40XUVPL, oil	1.30	0.12	4.34	Iris diaphragm, Spring-loaded.
	100XUVPL, oil	1.30	0.12	1.88	Iris diaphragm, Spring-loaded.

Magnification	Numerical Aperture	Working Distance mm	Focal Length mm	Remarks	
No Cover Objectives					
NC S Plan	40X, dry	0.70	0.45	4.19	S.W., Spring-loaded.
	100X, dry	0.95	0.30	1.70	S.W., Spring-loaded.
NC S Plan Apo	60X, dry	0.90	0.42	2.78	S.W., Spring-loaded.
NC S Plan Apo	100X, oil	1.40	0.15	1.62	S.W., Iris diaphragm, Spring-loaded.

Strain-free Objectives (for transmitted polarized light)

PO D Plan	4X, dry*	0.10	7.03	34.23	
	10X, dry	0.25	7.40	17.69	
	20X, dry	0.40	0.83	8.99	Spring-loaded.
	40X, dry	0.65	0.47	4.61	Spring-loaded.
	100X, oil	1.25	0.17	1.75	Spring-loaded.
PO D Ach	4X, dry*	0.10	18.23	30.03	
	10X, dry	0.25	7.18	16.90	
	20X, dry	0.40	1.63	8.63	Spring-loaded.
	40X, dry	0.65	0.62	4.58	Spring-loaded.
	100X, oil*	1.30	0.20	1.66	Spring-loaded.

Denote: S.W. = Super Widefield. PL = Positive Low Contrast. PLL = Positive Low-Low Contrast. NH = Negative High Contrast. NM = Negative Medium Contrast. D.I.C. = Nomarski Differential Interference Contrast. * = Can be used for specimens with/without cover.

LB Eyepiece Series

Field Number min ϕ	Eyepoint mm	Focal Length mm	Remarks
-------------------------	-------------	-----------------	---------

Widefield Eyepieces

GS-WHK 10X*	20	18.7	25.0	With built-in grain scale.
CWHK 10X	18	18.8	25.0	
WHK 8X	20	18.7	31.25	
WHK 10X	20	18.7	25.0	
WHK 10X H*	20	18.7	25.0	
WK 10X	20	15.8	25.0	
WK 10X H*	20	15.8	25.0	
WHK 12.5X	16	15.5	20.0	
WHK 12.5X H*	16	15.5	20.0	
WHK 15X	14	16.3	16.7	
Micro-WHK 10X*	20	18.7	25.0	Built-in 10/100 micrometer disc.
Cross-WHK 10X*	20	18.7	25.0	Built-in cross micrometer disc.
Micro-WK 10X*	20	15.8	25.0	Built-in 10/100 micrometer disc.
Cross-WK 10X*	20	15.8	25.0	Built-in cross micrometer disc.

Compensation Eyepieces

NK 5X	21	16.4	50.0	
NK 20X	10	10.4	12.5	

Super Widefield Eyepiece

SWHK 8X*	26.5	17.0	31.25	
SWHK 10X*	26.5	15.6	25.0	

Finder Eyepieces

35-WHK 10X*	20	18.7	25.0	With built-in mask for 35mm camera.	
P-WHK 10X*	20	18.7	25.0	With built-in mask for 3 1/4" x 4 1/4" Polaroid.	to be matched with WHK 10X
4 x 5-WHK 10X*	20	18.7	25.0	With built-in mask for 4" x 5" Polaroid	
35-SWHK 10X*	26.5	15.6	25.0	With built-in mask for 35mm camera.	
P-SWHK 10X*	26.5	15.6	25.0	With built-in mask for 3 1/4" x 4 1/4" Polaroid.	to be matched with SWHK 10X
4 x 5-SWHK 10X*	26.5	15.6	25.0	With built-in mask for 4" x 5" Polaroid.	

Photo Eyepieces

NFK 1.67XLD	—	—		
NFK 2.5XLD	—	—		
NFK 3.3XLD	—	—		
NFK 5XLD	—	—		
NFK 6.7XLD	—	—		

It takes a tremendous amount of skills to build a reputation as an innovator among industries as diverse as communications, medicine, information and science. Yet that's exactly what Olympus has accomplished since its inception in 1919. Our varied product list is filled with technological achievements and resounding successes. Not only in cameras, but also in a wide range of Microscopes. Fiberscopes. Microcassette recorders. Clinical analysis equipment. Video equipment. And more breakthroughs are on the way, particularly in the exciting new field of opto-electronics, which combines the resources of optics, electronics and precision engineering. At Olympus, we've earned our reputation with an unflinching commitment to heavy research and development. With an uncompromising dedication to quality, precision and accuracy. And with a stubborn unwillingness to follow the crowd. That's why we'll continue to lead the way with original products that surprise you, assist you, involve you, and fulfill you.

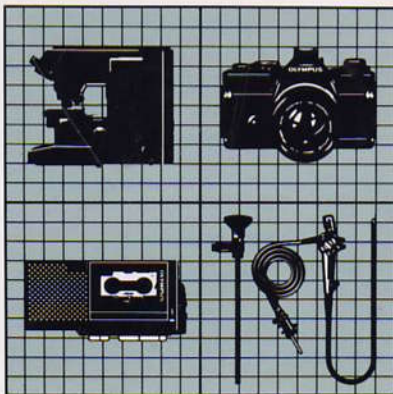

Photographic,
Medical,
Microscopic,
Industrial & Business Equipment

OLYMPUS

OLYMPUS OPTICAL CO., LTD.
San-Ei Building, 22-2, Nishi Shinjuku 1-chome, Shinjuku-ku, Tokyo, Japan
OLYMPUS OPTICAL CO. (EUROPA) GMBH
Postfach 104908, Wendenstrasse 14-16, 2000 Hamburg 1, Germany
OLYMPUS CORPORATION
4 Nevada Drive, Lake Success, N.Y. 11042-1179, U.S.A.
OLYMPUS OPTICAL CO. (U.K.) LTD.
2-8 Honduras Street, London EC1Y0TX

As we are continually improving and developing our products, the equipment supplied may not agree in all details with the descriptions and/or illustrations shown in this catalog.